

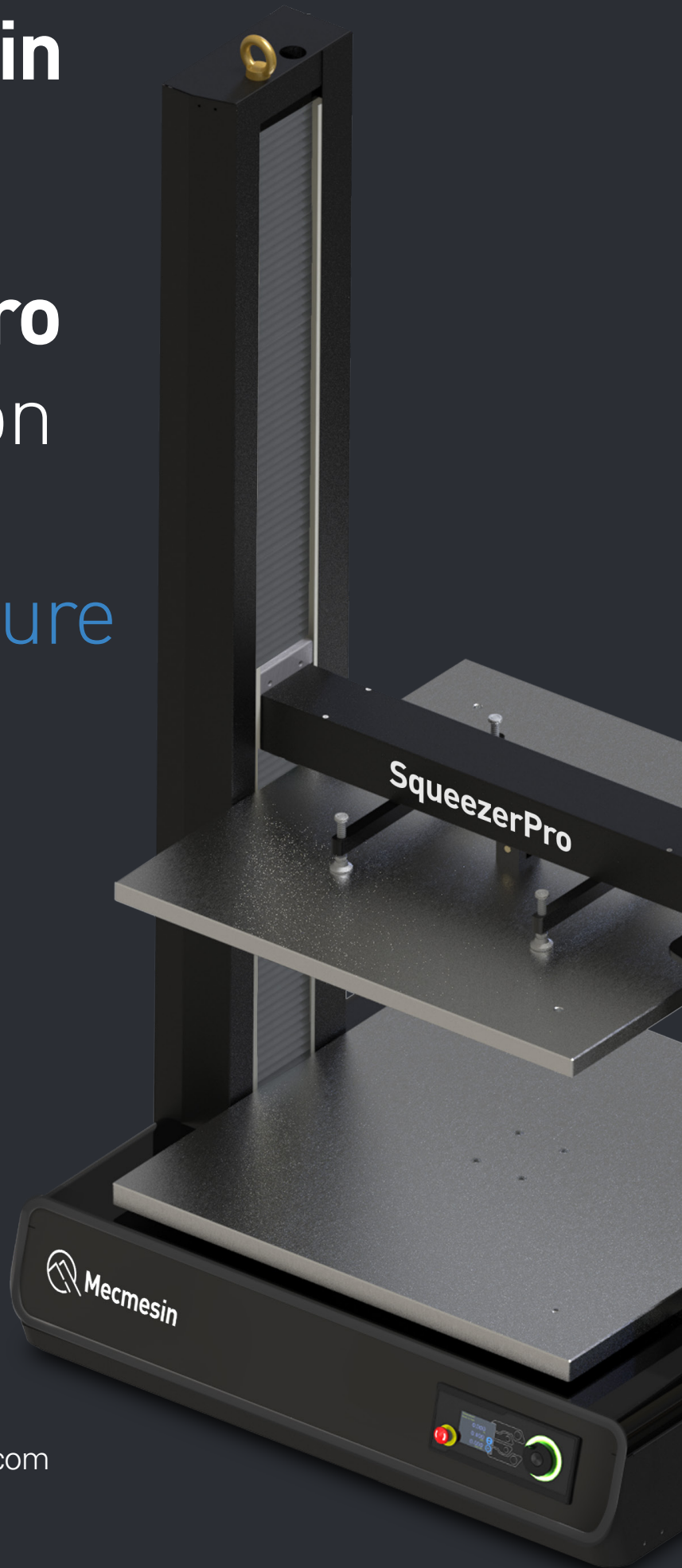

SqueezerPro
Compression
tester
Sales brochure



mecmesin.com

Explore the new SqueezerPro

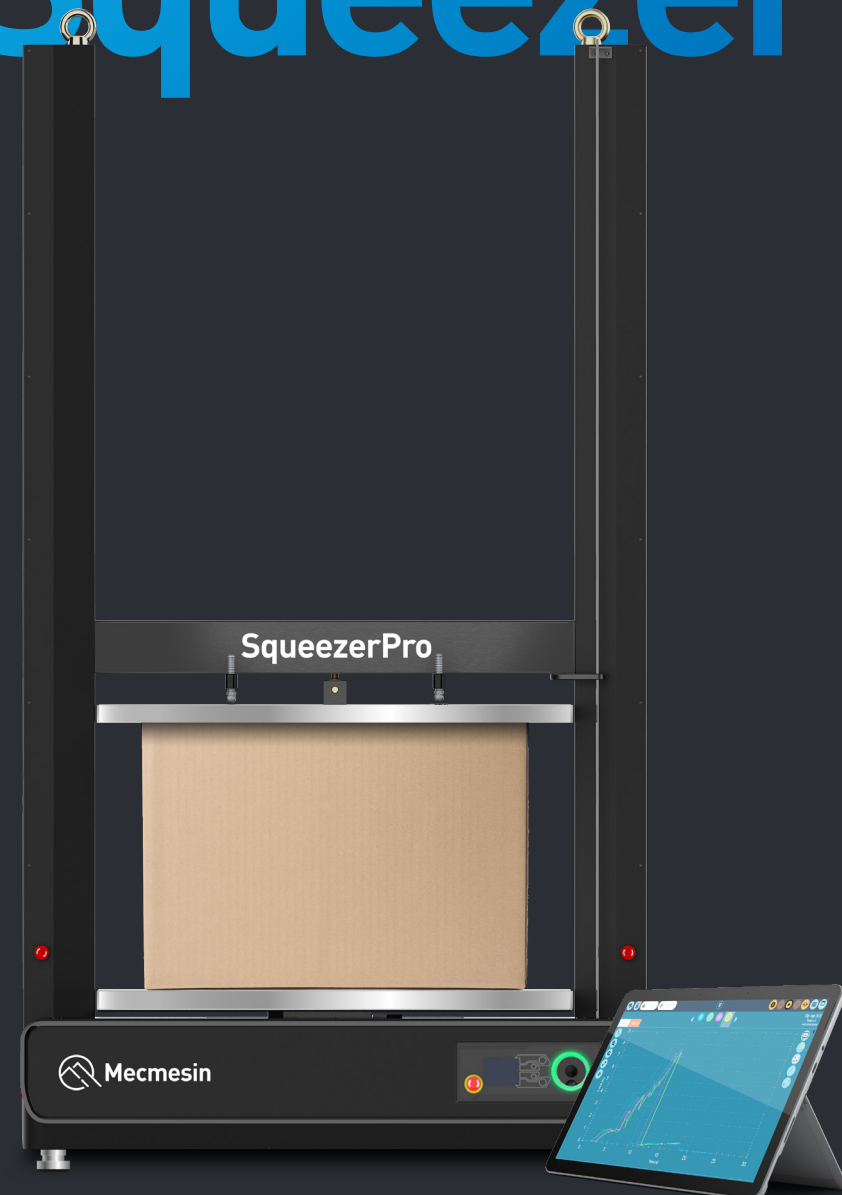

Crafted to evaluate box performance, SqueezerPro offers powerful insights into the compressive strength performance of various board mediums, closures, interior partitions, and other critical design variables. Additionally, SqueezerPro can be used to conduct distribution simulation compression testing for individual packages.



SCAN HERE

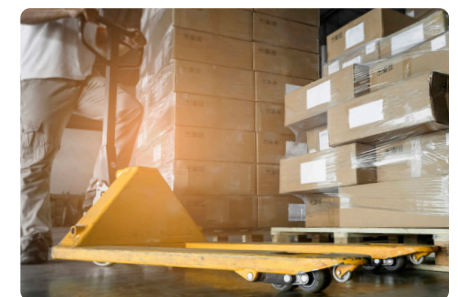



“ SqueezerPro offers unparalleled insights into compressive strength across various mediums and design variables. Integrated with VectorPro software, SqueezerPro simplifies testing processes for greater efficiency. ”

Carl Bramley, ISTA European Board Director

SqueezerPro

Compression tester

Mecmesin develop a comprehensive suite of compression test systems, including SqueezerPro, designed to assess the performance of unit loads, individual packages, components, and materials under compressive loads.

	SqueezerPro
Platen size (standard)	762 mm x 762 mm (30" x 30")
Platen size (extended)	1117 mm x 762 mm (44" x 30")
Platen configuration	Fixed or floating
Vertical daylight	1220 mm (48")
Max force	25 kN (5,500 lbf)



Key features

- Precision parallelism
- Greater accuracy
- Simple controls
- VectorPro test software
- Drag and drop interface
- Seamless data export



Powered by VectorPro software



Quality control

Ideal for research laboratory and quality control area testing.



Versatile anchors

M16 eye bolt(s) that can be removed to provide convenient M16 anchor points.



Precision bearings

Greater performance and longevity by minimising play in column bearings.



Accuracy & precision

Precision aligned specimen platforms for accurate test results, ensuring reliability and confidence in your testing outcomes.



Intuitive controls

Coloured LED controller provides clear status updates throughout testing.



Flexible programming

Tailor testing protocols to your specific requirements - maximising efficiency and productivity.

Test standards

SqueezerPro is purpose-built to comply with key international test standards, including ISTA 6-Amazon, D642-20, ISO 12048, Tappi T804, and more. Designed to evaluate the compressive strength of cardboard and fiberboard packaging, it ensures adherence to industry standards, providing accurate and reliable results for your testing needs.



D642-20, D4169, D4577-19, D7030-22



12048



Proc. 2A 2001, Proc. 2B 2001 Proc. 3H 11-14,
Project 6 Amazon.com SIOC 18-18



T 804



VectorPro[®] software

Software core functionality

Dedicated to enhancing your testing experience, VectorPro software is specifically designed for the SqueezerPro compression tester. Seamlessly integrated, it simplifies test routine creation, data acquisition, and analysis.

Whether connected to your PC or optional touchscreen controller, VectorPro provides a user-friendly environment. Its adaptive interface guides configuration seamlessly, presenting only relevant parameters. Experience the power of VectorPro and elevate your testing capabilities with SqueezerPro.

Key Features

- Real-time graph plotting
- Immediate display of results
- Full data export
- Customised report generation
- Drag and drop interface
- Personalized workspace
- Secure user accounts



Powered by
VectorPro[®]



Your step-by-step guide to getting started

01 | Login



02 | Select

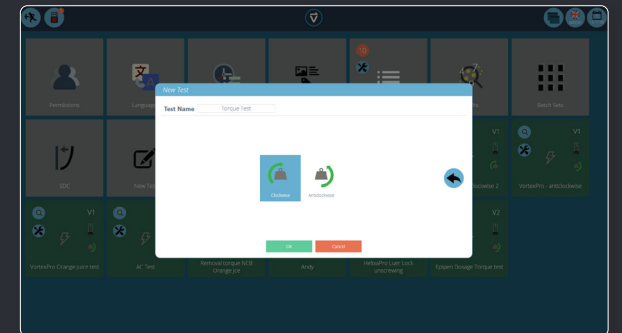

03 | Design

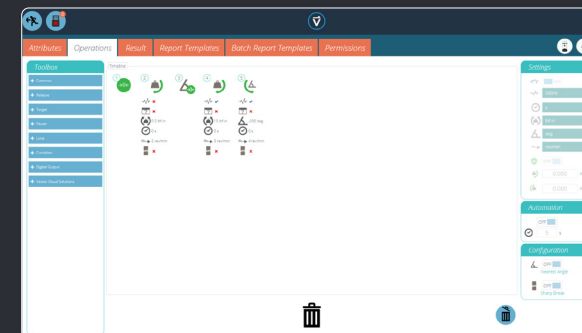

04 | Analyse



05 | Report



06 | Share

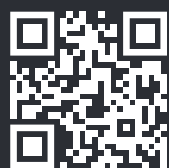
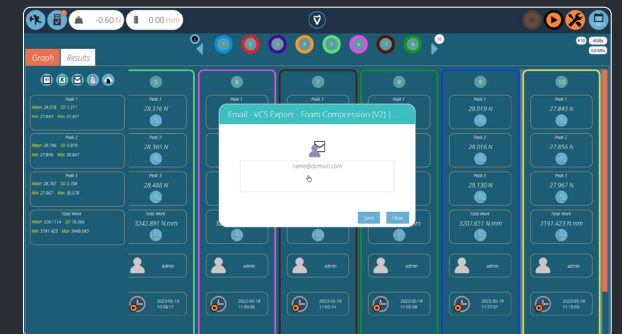

Discover VectorPro software
visit vectorpro.io



Touchscreen test software

Test reporting

Compression functionality

VectorPro is our advanced force measurement software, featuring batch testing functionality that uses pre-configured tests to create semi-automatic or fully automatic testing on groups of products and product batches. This feature simplifies testing by automatically creating the new test with a graph for every sample, exporting data and printing test reports. Test reports can display overlay graphs or individual test graphs. Batch testing enables monitoring of the batch progress and can be started, paused and restarted at any time.

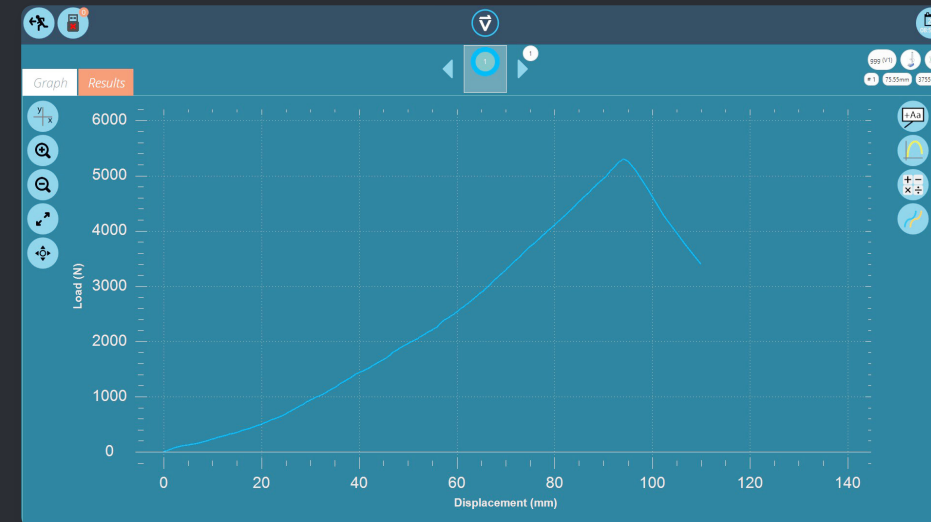

▲ Real-time graph plotting of tests

VectorPro can display real-time force measurement and deflection. Measure Maximum Force using a predefined test standard or your own custom test programs. VectorPro's cloud connectivity enables users to easily share test programs and test results with colleagues.

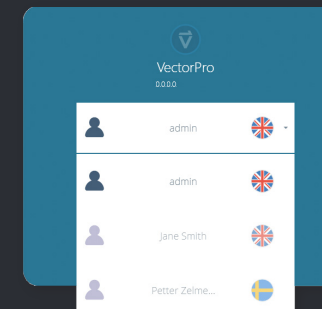

User access

VectorPro also features role management and event logging, enabling supervisors to authorize actions with a digital signature, providing a complete testing audit trail.

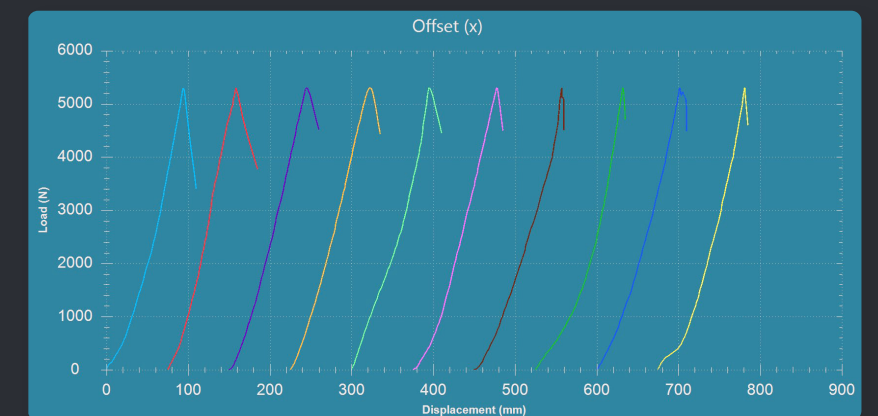

▲ Graphical output with tagged curves

SqueezerPro (25kN) Specifications



Load		
Rated capacity	N	25000
	kN	25
	kgf	2549
	lbf	5500
Force accuracy	+/- 0.5% of reading, EN ISO 7500-1:2015 Class 0.5 ASTM E4	
Resolution	1:50,000	
Data acquisition rate (max)	1000 Hz	
Platen configuration	Fixed or floating	
Dimensions*		
Distance between columns	800 mm (31")	
Height	1967 mm (77.5")	
Width	1108 mm (44")	
Depth	930 mm (37") Machine only	
Vertical daylight	1440 mm (48")	
Weight (instrument only)	Approx 400 kg (880 lbs)	
Speed		
Range	mm/min	0.01 - 1000
	in/min	0.0004 - 39.4
Resolution	mm/min	0.001
Accuracy	Better than ±2% of indicated speed or ±20 microns/minute, whichever is greater	
Displacement		
Crosshead travel*	1220 mm (48")	
Resolution	0.001 mm (1 micron)	
Accuracy	±0.1% of indicated position or ±0.01mm (10 microns), whichever is greater	
Electrical supply		
Voltage	230V AC 50 Hz or 110V AC 60 Hz	
Max power	750W	
Environment specification		
Operating temperature	10°C - 40°C	
Operating relative humidity	30-80% non-condensing	

*Measured without fixtures

SqueezerPro Dimensions

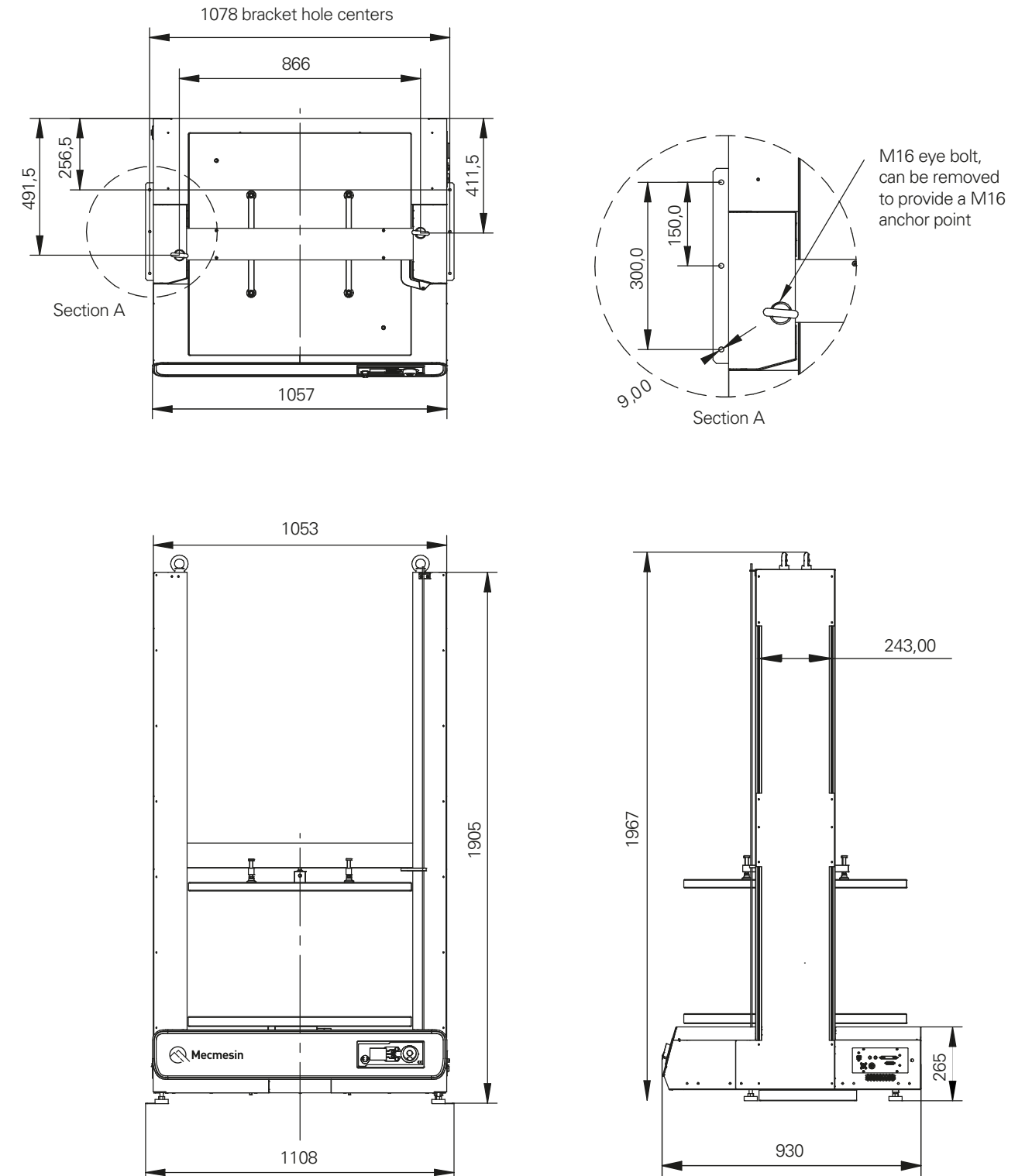

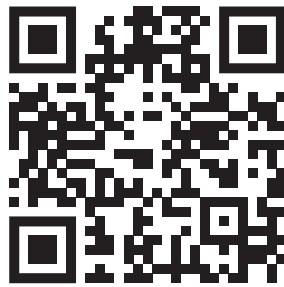

mecmesin.com