

KERN

KERN & Sohn GmbH

Ziegelei 1
D-72336 Balingen
E-Mail: info@kern-sohn.com

Tel: +49-[0]7433-9933-0
Fax: +49-[0]7433-9933-149
Internet: www.kern-sohn.com

Operating instructions Medical Chair scale

KERN MCC

MCC 250K100NM
Version 3.2
2018-12
GB



MCC-NM-BA-e-1832

D	Weitere Sprachversionen finden Sie online unter www.kern-sohn.com/manuals
BG	Други езикови версии ще намерите в сайта www.kern-sohn.com/manuals
DK	Flere sprogudgaver findes på websiden www.kern-sohn.com/manuals
EST	Muud keeleversioonid leiate Te leheküljel www.kern-sohn.com/manuals
SP	Más versiones de idiomas se encuentran online bajo www.kern-sohn.com/manuals
GR	Άλλες γλωσσικές αποδόσεις θα βρείτε στην ιστοσελίδα www.kern-sohn.com/manuals
F	Vous trouverez d'autres versions de langue online sous www.kern-sohn.com/manuals
LV	Citas valodu versijas atradīsiet vietnē www.kern-sohn.com/manuals
FIN	Muut kieliversiot löytyvät osoitteesta www.kern-sohn.com/manuals
LT	Kitas kalbines versijas rasite svetainėje www.kern-sohn.com/manuals
EN	Further language versions you will find online under www.kern-sohn.com/manuals
RO	Alte versiuni lingvistice veți găți pe site-ul www.kern-sohn.com/manuals
I	Trovate altre versioni di lingue online in www.kern-sohn.com/manuals
SK	Iné jazykové verzie nájdete na stránke www.kern-sohn.com/manuals
NL	Bijkomende taalversies vindt u online op www.kern-sohn.com/manuals
SLO	Druge jezikovne različice na voljo na spletni strani www.kern-sohn.com/manuals
P	Encontram-se online mais versões de línguas em www.kern-sohn.com/manuals
CZ	Jiné jazykové verze najdete na stránkách www.kern-sohn.com/manuals
PL	Inne wersje językowe znajdą Państwo na stronie www.kern-sohn.com/manuals
SE	Övriga språkversioner finns här: www.kern-sohn.com/manuals
H	A további nyelvi változatok a következő oldalon található: www.kern-sohn.com/manuals
HR	Druge jezične verzije su dostupne na stranici: www.kern-sohn.com/manuals
NO	Andre språkversjoner finnes det på www.kern-sohn.com/manuals



KERN MCC

Version 3.2 2018-12

Operating manual chair

Contents

1	Technical data	5
2	Declaration of conformity	6
2.1	Explanation of the graphic symbols	6
3	Appliance overview	9
3.1	Overview of display	12
3.2	Keyboard overview	13
3.3	Dimensions	14
4	Basic Information (General)	15
4.1	Specific function	15
4.2	Proper use	15
4.3	Improper Use	16
4.4	Warranty	16
4.5	Monitoring of Test Resources	17
5	Basic Safety Precautions	17
5.1	Pay attention to the instructions in the Operation Manual	17
5.2	Personnel training	17
5.3	Preventing contamination	17
5.4	Appropriate use	17
6	Electromagnetic compatibility (EMC)	18
6.1	General hints	18
6.2	Electromagnetic interferences	19
6.3	Electromagnetic noise immunity	20
6.3.1	Crucial features of performance	22
6.4	Minimum distances	22
7	Transport and storage	23
7.1	Testing upon acceptance	23
7.2	Packaging / return transport	23
8	Unpacking, Setup and Commissioning	24
8.1	Place of installation / place of operation	24
8.2	Unpacking	24
8.3	Scope of delivery	24
8.4	Installing the chair scales	25
8.4.1	Levelling	26
8.5	Mains connection	28
8.5.1	Safety cable	28
8.6	Rechargeable battery operation	29
8.7	Battery operation	30

8.8	Initial Commissioning.....	31
9	Operation.....	32
9.1	Weighing.....	32
9.2	Taring.....	33
9.3	HOLD function	34
9.4	See second decimal point (not verified value)	34
9.6	Calculation of the Body Mass Index	35
9.6.1	Classification of BMI values	35
9.7	Automatic switch-off function „AUTO OFF“	36
9.8	Display background illumination.....	37
10	Menu	38
10.1	Navigation in the menu.....	38
10.2	Menu overview	39
11	Error messages.....	40
12	Service, maintenance, disposal.....	41
12.1	Cleaning	41
12.2	Cleaning / disinfecting	41
12.3	Sterilisation	41
12.4	Service, maintenance	41
12.5	Disposal.....	41
13	Instant help.....	42
14	Verification	43
14.1	Verification validity period (current status in G).....	44
15	Adjustment	45
16	Accessories.....	47
17	Printers	47

1 Technical data

KERN (Type)	MCC 250K100NM
Model	MCC 250K100M
Readability (d)	0.1 kg
Weighing range (max)	250 kg
Minimum weight (min)	2 kg
Verification value (e)	100 g
Verification class	III
Reproducibility	0.1 kg
Linearity	±0.1 kg
Recommended adjustment weight (Class)	200 kg (M1)
Weighing Units	kg
Warm-up time	10 min
Electric Supply	Input voltage: 100 V - 240 V AC 50 Hz
Operating temperature	0°C ... + 40°C
Humidity of air	max. 80 % (not condensing)
Dimensions (W x D x H) mm	625 x 990 x 985
Dimensions Weighing surface	507 x 380
Weight kg (net)	23.3
Rechargeable battery operation	Series
Medical product in accordance with 93/42/EEC	Category I with measuring function
Verification according to 2014/31/EU	class III

2 Declaration of conformity

To view the current EC/EU Declaration of Conformity go to:

www.kern-sohn.com/ce

i The scope of delivery for calibrated weighing balances (= conformity-rated weighing balances) includes a Declaration of Conformity.

Solely these weighing balances are classified as medical devices.

2.1 Explanation of the graphic symbols

All medical scales marked in this way meet the requirements of the following directives:

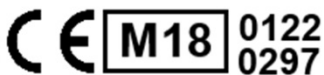

1. 2014/31/EU: Directive on non-automatic weighing instruments
2. 93/42/EC: Directive concerning medical devices



Scales marked in this way underwent the conformity assessment procedure according to Directive 2014/31/EU for scales belonging to 3rd accuracy class.

WF 1734331

Designation of the serial number of every device, applied at the device and on the packaging

Number here as example



Identification of the manufacturing date of the medical product.

Year and month here as example

2018-12



“Please note the accompanying documents“
or “Please note operating instructions”



“Please note operating instructions”



“Please note operating instructions”



Identification of manufacturer of medical product including
address

Kern & Sohn GmbH
D-72336
Balingen, Germany
www.kern-sohn.com



“Electro-medical appliance“
with attachment for type B

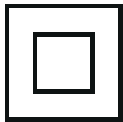

Device protection category II



Dispose of old appliances separately from your household
waste!

Instead, take them to communal collection points.



Display of supply voltage for scales with polarity display.



Do not use the chair scales to transport people and objects!
Do not stand on the footrests when you get on or off the chair scales!

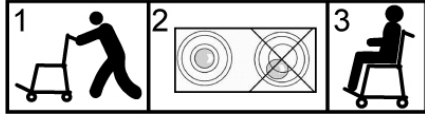

After taking chair scales to patient, ensure scales are level before starting the weighing process.

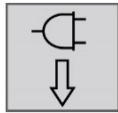

Power connection



Seal KERN SEAL



Supply voltage current



Information

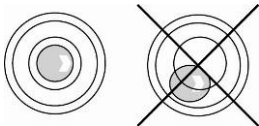

Level the balance before use

3 Appliance overview

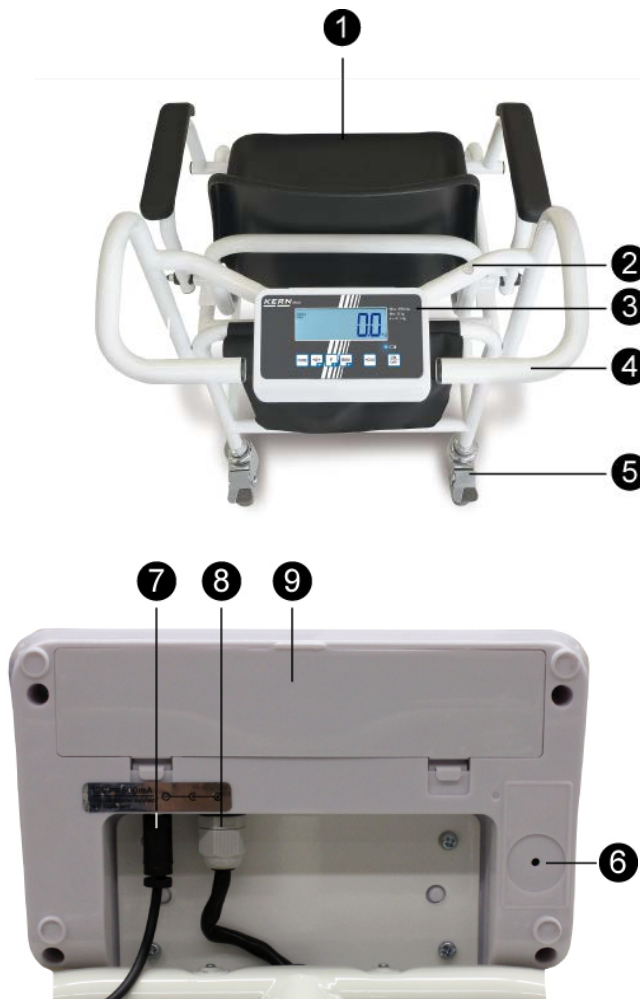

1. Seat pan
2. Bubble level
3. Display Unit
4. Manipulations
5. Parking brake
6. Adjustment switch
7. Terminal power supply unit
8. Connection cable "Display - Chair"
9. Battery compartment

Details:



Parking brake open



Parking brake closed







Foot rest and adjustment foot

Folding arm rests

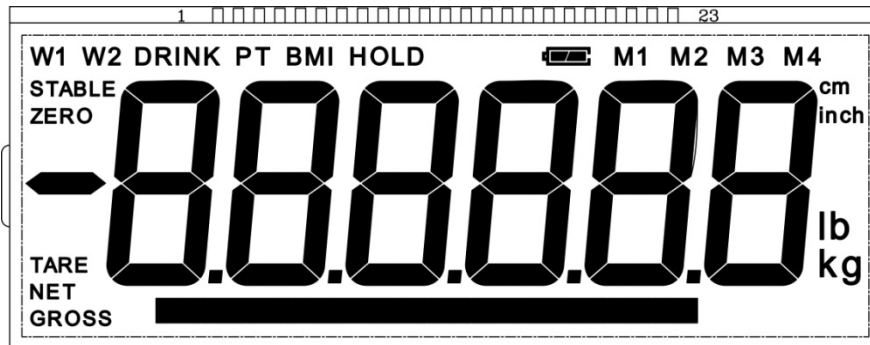







3.1 Overview of display

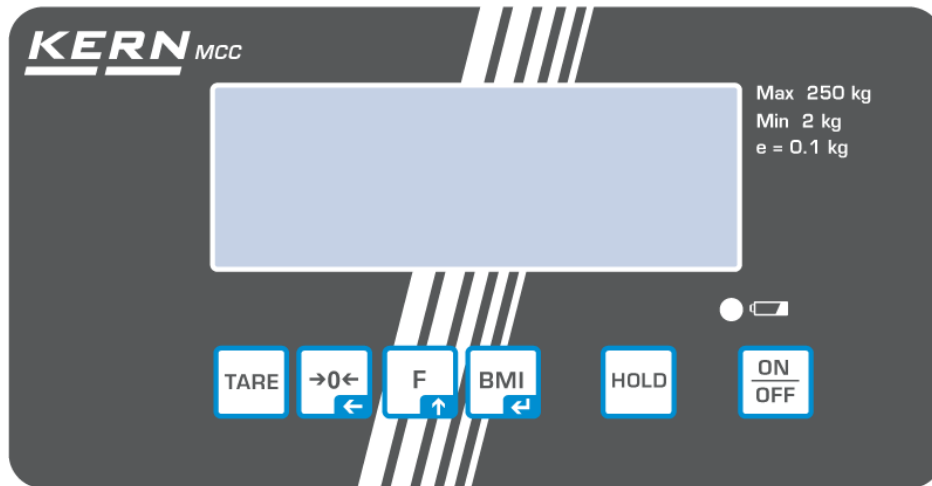

Display	Description	Description
GROSS	Gross weight display	Lights up during indication of the gross weight
NET	Net weight display	Lights up during indication of the net weight Illuminated after weighing scale was tared
ZERO	Zeroing display	Should the balance not display exactly zero despite empty scale pan, press the  button. Your balance will be set to zero after a short standby time.
STABLE	Stability display	Scales are in a steady state
BMI	Body Mass Index	Is actively displayed during active BMI function
HOLD	HOLD function	Is displayed with active hold function
	Rechargeable battery symbol	Lights when the voltage drops below the prescribed minimum.
		Lights when the rechargeable battery capacity is almost exhausted.
		Lights when the rechargeable battery is fully charged.

3.2 Keyboard overview



Key	Description	Function
	ON/OFF-switch	Turn on/off
	HOLD button	Hold function
	BMI key	Calculation of the Body Mass Index In menu: <ul style="list-style-type: none"> • Confirm selection For numeric entry: <ul style="list-style-type: none"> • Confirm numerical value
	Function key	In menu: <ul style="list-style-type: none"> • Call up menu • How to select menu items For numeric entry: <ul style="list-style-type: none"> • Increase numerical value
	Zero setting key	Weighing scale will be reset to „0.0“ For numeric entry: <ul style="list-style-type: none"> • Change decimal place
	TARE key	Tare balance

3.3 Dimensions

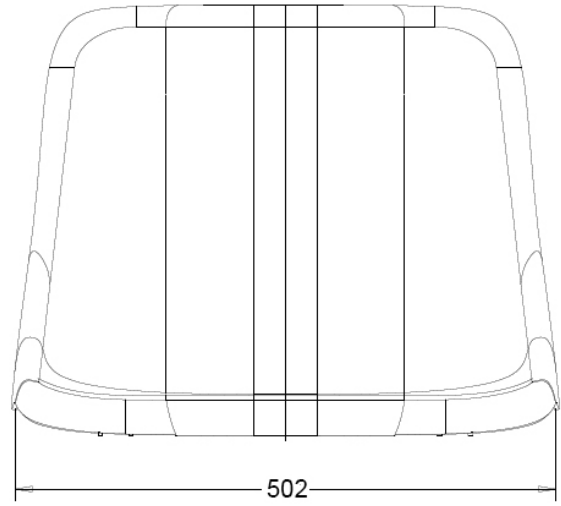
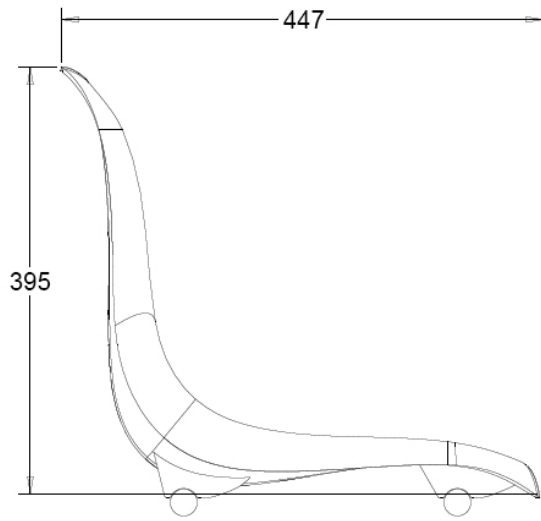

4 Basic Information (General)



Weighing instruments have to be verified for the purposes stated below in accordance with Directive 2014/31/EU. Article 1, paragraph 4. "Determination of mass in the practice of medicine that is, weighing patients for reasons of medical supervision during medical surveillance, examination and treatment."

4.1 Specific function

- Indication**
- Determining the body weight in the medical practice area.
 - Use as „non-standalone weighing scale“, that is, a person sits carefully onto the seating surface's centre. Once a steady display value is shown, you can read the weight value.

- Contraindication**
- No contraindication known

4.2 Proper use

These scales are used to determine weight of people sitting at rest in medical treatment rooms. The scales are suitable for recognising, preventing and controlling illnesses.



The person should be weighed carefully and have contact with the center of the seat, sit and stay calm.

As soon as a stable weighing value is reached the weighing value can be read. The scales are designed for long-term usage.



The instruments shall only be used by people who can sit still.

The balances should be checked for correct condition prior to each utilisation by a person familiar with proper operation of the balance.

	
<ul style="list-style-type: none"> • Do not use the chair scales to transport people and objects! • Until the weighed person stays on the chair scales, the wheel brakes must always be activated. • The armrests of the chair scales are designed solely for resting arms and not for supporting. • When going off and on, a trained person should fold the armrests up (raise) and help the weighed person. • The chair scales should always be placed on flat, smooth surface. • Do not stand on the footrests when you get on or off the chair scales! 	

4.3 Improper Use

Do not use these scales for dynamic weighing processes.

No permanent load on the seat area. This may damage the measuring system. Impacts and overloading exceeding the stated maximum load (max) of the seating surface, minus a possibly existing tare load, must be strictly avoided. This could cause damage to the balance.

Never operate balance in explosive environment. The serial version is not explosion protected. It should be noted that a flammable mixture of anaesthetics and oxygen or laughing gas may occur.

Do not modify the construction of the scales. This may lead to incorrect weighing results, safety-related faults and destruction of the balances.

The balances may only be used according to the described conditions. Other areas of use must be released by KERN in writing.

4.4 Warranty

Warranty claims shall be voided in case



- Our conditions in the operation manual are ignored
- The appliance is used outside the described uses
- Modification or opening of appliances
- Mechanical damage and damage caused by media, liquids,
- Natural wear and tear
- The appliance is improperly set up or incorrectly electrically connected
- The measuring system is overloaded
- Dropping of scales

4.5 Monitoring of Test Resources

In the framework of quality assurance the measuring-related weighing properties of the balances and, if applicable, the testing weight, must be checked regularly. The responsible user must define a suitable interval as well as type and scope of this test. Information is available on KERN's home page (www.kern-sohn.com) with regard to the monitoring of balance test substances and the test weights required for this. In KERN's accredited DKD calibration laboratory test weights and balances may be calibrated (return to the national standard) fast and at moderate cost.

5 Basic Safety Precautions

5.1 Pay attention to the instructions in the Operation Manual

	⇒ Carefully read this operation manual before setup and commissioning, even if you are already familiar with KERN balances.	
---	---	---

5.2 Personnel training

The medical staff must apply and follow the operating instructions for proper use and care of the product.

5.3 Preventing contamination

The prevention of cross-contamination (fungal skin infections,.....) requires regular cleaning of the seating surface.

Recommendation: after a weighing procedure that could potentially result in contamination (e. g. after weighing that involves direct skin contact).

5.4 Appropriate use

	Do not use the chair scales to transport people or objects!
---	---

- Always get on and off the chair scales in the presence of a qualified person (see Chapter 5.2)
- Before every use inspect the scales for any signs of damage.
- Maintenance and repeated verification
Chair scales should be maintained and verified at regular intervals (see chapter 12.4)

6 Electromagnetic compatibility (EMC)

6.1 General hints



The installation and use of this electrical medical device requires special precautionary measures as outlined in the EMC information below.

This device complies with the limits set for medical electrical devices of group 1, class B (as per EN 60601-1-2).

Electromagnetic compatibility (EMC) describes a device's ability to perform reliably within an electromagnetic environment without causing inadmissible electromagnetic interference at the same time. Amongst other things, such disturbances may be emitted by connecting cables or the air.

Inadmissible disturbances from the environment may result in incorrect displays, inaccurate measured values or incorrect behaviour of the medical device. By the same token the medical device may in some cases cause such disturbances in other devices. To eliminate problems of that kind, we recommend you to take one or several of the measures listed below:

- Change the alignment or distance of the device to the source of EMI.
- Install or use the chair scale MCC-NM at a different location.
- Connect the chair scale MCC-NM to a different power source.
- For further questions please contact our customer services.

Disturbances may be caused by improper modification or add-ons to the device or not recommended accessories (such as power units or connecting cables). The manufacturer will not be responsible for these. Modifications may also result in a loss of authorisation relating to the use of the device.



Devices emitting high frequency signals (mobile telephones, radio transmitters, radio receivers) may cause interference in the medical device. For that reason do not use them near the medical device. Chapter 6.4 contains details about recommended minimum distances.

6.2 Electromagnetic interferences

Guidelines and manufacturer's declaration – electromagnetic interferences		
The chair scale MCC-NM is designed for use in an electromagnetic environment that meets the requirements stated below. The customer or user of the medical electrical device must ensure that operation takes place in such an environment.		
Emitted interference measurements	Conformity	Electromagnetic environment - guideline
HF emissions as per CISPR 11 / EN 55011	Group 1	The chair scale MCC-NM uses HF energy merely for its internal working. Its HF emission therefore is very low and it is highly unlikely to interfere with adjacent electronic devices.
HF emissions as per CISPR 11 / EN 55011	Class B	The chair scale MCC-NM is designed for use in all equipment including those in living areas and those connected directly to the public power grid that also supplies buildings used for living purposes.
Emission of harmonics as per IEC 61000-3-2	Class A	
Emission of voltage fluctuations / flicker as per IEC 61000-3-3	Conforms with	

Do not put the chair scale MCC-NM directly next to other devices and do not stack it with other devices. If this type of operation is necessary, observe the chair scale MCC 250K100M to ensure normal operation in such an arrangement.

6.3 Electromagnetic noise immunity

Guidelines and manufacturer's declaration - electromagnetic noise immunity			
The chair scale MCC-NM is designed for use in an electromagnetic environment that meets the requirements stated below. The customer or user of the medical electrical device must ensure that operation takes place in such an environment.			
Noise immunity tests	IEC 60601 test level	Conformity	Electromagnetic environment - guideline
Discharge static electricity (DSE) as per IEC 61000-4-2	± 6 kV contact discharge ± 8 kV air discharge	± 6 kV ± 8 kV	Floors should be made of wood or concrete or tiled with ceramic tiles. If floors are covered with synthetic material, relative air humidity must be at least 30%.
Fast transient electrical disturbances / bursts as per IEC 61000-4-4	± 2 kV for power lines ± 1 kV for input and output lines	± 2 kV ± 1 kV	The quality of the supply voltage should match that of the typical business or hospital environment.
Impulse voltages / surges as per IEC 61000-4-5	± 1 kV voltage Live wire - live wire ± 2 kV voltage Live wire - earth	± 1 kV Inapplicable	The quality of the supply voltage should match that of the typical business or hospital environment.
Voltage dips, short-term disruptions and fluctuations in supply voltage as per IEC 61000-4-11	< 5 % U_T (> 95 % dip of U_T) for ½ period 40 % U_T (> 60 % dip of U_T) for 5 periods 70 % U_T (> 30 % dip of U_T) for 25 periods < 5 % U_T (> 95 % dip of U_T) for 5 s	Compliance with requirements under all postulated conditions Controlled switch off Return to undisturbed situation after user intervention.	The quality of the supply voltage should match that of the typical business or hospital environment. Where the user of the chair scale MCC-NM demands continuous operation even during disruptions to the power supply, we recommend powering the chair scale MCC-NM by no-break power supply or battery.
Magnetic field for supply frequency (50/60 Hz) as per IEC 61000-4-8	3 A/m	3 A/m 50/60 Hz	Magnetic fields for the supply frequency should match the typical values found in the particular business or hospital environment.
NOTE U_T equals AC line voltage prior to application of test level.			

Guidelines and manufacturer's declaration - electromagnetic noise immunity

The chair scale MCC-NM is designed for use in an electromagnetic environment that meets the requirements stated below. The customer or user of the medical electrical device must ensure that operation takes place in such an environment.

Noise immunity tests	IEC 60601 test level	Conformity	Electromagnetic environment - guideline
Conducted HF disturbance variables as per IEC 61000-4-6	3 V_{rms} 150 kHz to 80 MHz	3 V	Do not use portable or mobile radio sets nearer to the chair scale MCC-NM or its wires than the distance recommended as safety distance which is calculated according to the equation relevant for its transmission frequency.
Emitted HF disturbance variables as per IEC 61000-4-3	3 V_{rms} 80 MHz to 2.5 GHz	3 V/m	<p>Recommended safety distance:</p> $d = 1.2\sqrt{P}$ <p>for 80 MHz to 800 MHz</p> $d = 2.3\sqrt{P}$ <p>for 800 MHz to 2.5 GHz</p> <p>Use P as rated capacity of radio transmitter in Watt (W) as per details given by the radio transmitter manufacturer and d as recommended safety distance in metres (m).</p> <p>The field intensity of stationary radio transmitters should for all frequencies be lower according to an in situ^a examination than the conformity level.^b</p> <p>Interference may occur near devices bearing the symbol below.</p>



NOTE 1 Higher frequency range applies to 80 MHz and 800 MHz.

NOTE 2 These guidelines may not be applicable in all cases.
The spread of electromagnetic variables is influenced by absorption and reflections in buildings, objects and humans.

^a The field intensity of stationary radio transmitters such as base stations of wireless telephones and mobile radio sets, amateur radio stations, AM and FM radio and television stations cannot be reliably predicted in advance. To determine the electromagnetic environment in respect of stationary transmitters, you should consider a study of electromagnetic phenomena at the location. If the measured field intensity at the location where the chair scale MCC-NM is to be used exceeds the conformity level above, you should observe the chair scale MCC-NM in order to ensure normal operation. If you observe unusual features of performance you may have to take additional measures such as a change in alignment or a different location for the chair scale MCC-NM.

^b For a frequency range of 150 kHz to 80 MHz field intensity should be less than 3 V/m.

6.3.1 Crucial features of performance



The chair scale MCC-NM does not have any crucial features of performance as per IEC 60601-1. The system may be subject to interference by other devices even if these devices conform to current emission requirements as per CISPR.

6.4 Minimum distances

Recommended safety distances between portable and mobile HF telecommunication devices and the medical device			
The chair scale MCC-NM is designed for use in an electromagnetic environment in which HF disturbance variables are controlled. The customer or user of the medical electrical device can help avoiding electromagnetic disturbances by keeping the minimum distance between portable and mobile HF telecommunication devices (transmitters) and the chair scale MCC-NM – depending on the output performance of the communication device, as stated below.			
Rated capacity of transmitter W	The safety distance depends on the transmission frequency m		
	150 kHz to 80 MHz $d = 1.2\sqrt{P}$	80 MHz to 800 MHz $d = 1.2\sqrt{P}$	800 MHz to 2.5 GHz $d = 2.3\sqrt{P}$
0.01	0.12	0.12	0.23
0.1	0.38	0.38	0.73
1	1.20	1.20	2.30
10	3.80	3.80	7.30
100	12.00	12.00	23.00
For transmitters with a maximum rated capacity not stated in the table above you can calculate the recommended safety distance in metres (m) yourself by using the equation belonging to each column, whereby P equals the maximum rated capacity of the transmitter in Watt (W) as per details provided by the transmitter manufacturer.			
NOTE 1 Higher frequency range applies to 80 MHz and 800 MHz.			
NOTE 2 These guidelines may not be applicable in all cases. The spread of electromagnetic variables is influenced by absorption and reflections in buildings, objects and humans.			

7 Transport and storage

7.1 Testing upon acceptance

When receiving the appliance, please check packaging immediately, and the appliance itself when unpacking for possible visible damage.

7.2 Packaging / return transport



- ⇒ Keep all parts of the original packaging for a possibly required return.
- ⇒ Only use original packaging for returning.
- ⇒ Prior to dispatch disconnect all cables and remove loose/mobile parts.
- ⇒ Reattach possibly supplied transport securing devices.
- ⇒ Secure all parts against shifting and damage.

8 Unpacking, Setup and Commissioning

8.1 Place of installation / place of operation

The balances are designed in a way that reliable weighing results are achieved in common conditions of use. You will work accurately and fast, if you select the right location for your balance.

On the installation site observe the following:

- Place scales on a stable, even surface
- Avoid extreme heat as well as temperature fluctuation caused by installing next to a radiator or in the direct sunlight;
- Protect the balance against direct draughts due to open windows and doors;
- Avoid jarring during weighing;
- Protect the balance against high humidity, vapours and dust;
- Do not expose the device to extreme dampness for longer periods of time. Non-permitted condensation (condensation of air humidity on the appliance) may occur if a cold appliance is taken to a considerably warmer environment. In this case, acclimatize the disconnected appliance for ca. 2 hours at room temperature.
- Avoid static charge of the balance and of the person to be weighed.
- Avoid contact with water.

Major display deviations (incorrect weighing results) may be experienced should electromagnetic fields (e.g. due to mobile phones or radio equipment), static electricity accumulations or instable power supply occur. In that case, the location must be changed.

8.2 Unpacking

Remove the individual components of the balance or the complete balance from the packaging with care and install at the intended location. When using the power pack, ensure that the power cable does not produce a risk of stumbling.

8.3 Scope of delivery

- Balance
- Operating instructions
- Mains adapter (as per EN 60601-1)
- Accessory Bag

8.4 Installing the chair scales



- ⇒ Place scales on an even surface.
- ⇒ Check if the air bubble of the level is within the prescribed circle.

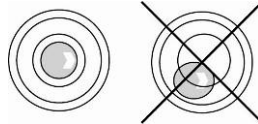

- ⇒ If the air bubble of the bubble level is **not** in the required circle, level the balance using the adjustment feet as specified in the following chapter 8.4.1:
- ⇒ Check levelling regularly.

8.4.1 Levelling



⇒ Levelling is restricted to specialist staff possessing well acquainted with the workings of weighing scales.

⇒ Place scales on an even surface.

⇒ Lock brakes



⇒ Turn the wheel (1) until the air bubble of the bubble level is in the black circle

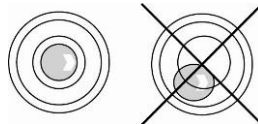
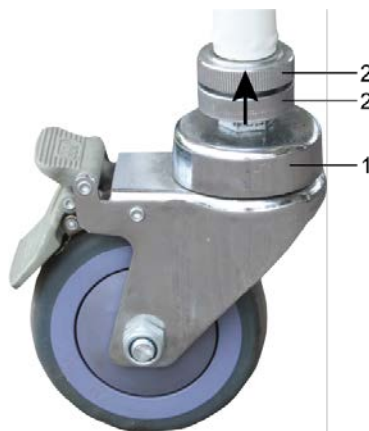

⇒ Turn the counter-nuts (2) right to the top.

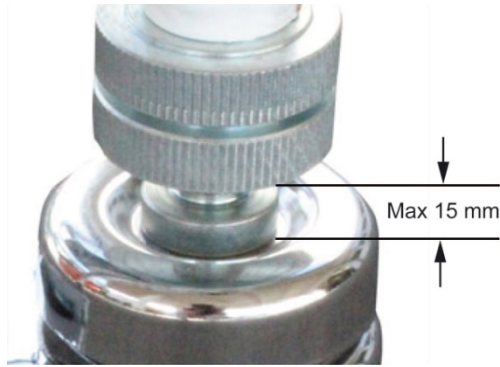

Gap width must not exceed 15 mm!

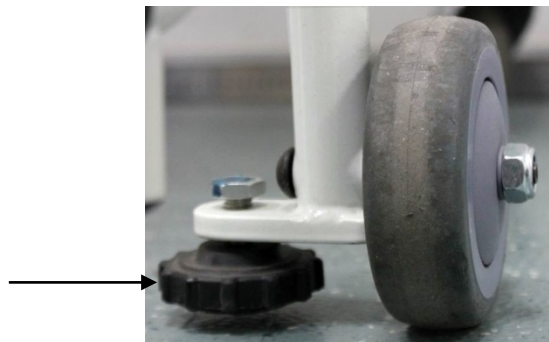

Use the adjustment feet to fix the chair at the front rollers

8.5 Mains connection



Terminal power supply unit

Power is supplied via the external mains adapter. The printed voltage must correspond to the local voltage.

Only approved genuine KERN power supply units may be used in compliance with Directive EN 60601-1.

The small sticker attached to the side of the display unit indicates the power port:



The LED remains illuminated as long as the weighing scale remains connected to the mains. The LED display provides information about the battery's charging status.

Green: battery is fully charged

Blue: battery is charging

8.5.1 Safety cable

Safety cable for strain relief of the mains cable.



Application:

Installation for strain relief between mains cable (plug-in power supply unit) and display unit.

8.6 Rechargeable battery operation





Open the battery compartment cover (1) at the base of the display unit and insert the rechargeable battery pack.

Charge the battery for at least 12 hours before initial use.

The appearance of the symbol  in the weight display indicates that the battery pack is almost exhausted. The weighing scale will remain ready for operation for a few more minutes before switching off in order to save battery. Charge the battery pack.

 Voltage has dropped below prescribed minimum.

 Rechargeable battery very low.

 Rechargeable battery completely reloaded

If the balance is not used for a longer time, take out the battery pack and store it separately. Leaking liquid could damage the balance.

8.7 Battery operation

As an alternative to rechargeable battery operation, the balance may also be operated with 6x AA batteries.

Open battery compartment cover (1) at the lower side of the display unit and insert batteries according to the example below. Lock the battery cover again. If the batteries are empty, in the balance display appears the symbol . Change batteries. To save battery power, the balance switches off automatically (see chap.11.6 Auto off).



Capacity of batteries exhausted.





Batteries will soon be flat.

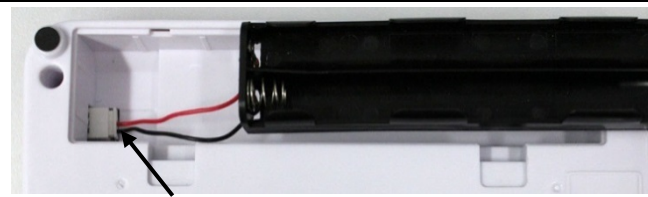

Batteries are completely charged

Insert batteries

Remove battery compartment cover	
Connect battery holder to housing contact acc. to illustration	
Insert battery holder	
Insert batteries into battery compartment and lock with battery compartment cover.	

8.8 Initial Commissioning

In order to obtain exact results with the electronic balances, your balance must have reached the operating temperature (see warming up time chap. During this warming up time the balances must be connected to the power supply (mains, accumulator or battery) and be switched on.

The accuracy of the balance depends on the local acceleration of gravity. The value of gravity acceleration is shown on the type plate.

9 Operation

After taking chair scales to patient, ensure scales are level before starting the weighing process. See diagram below

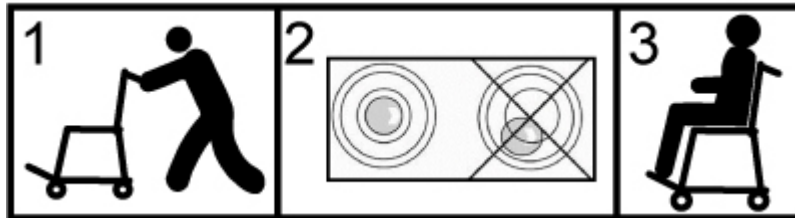

Always get on and off the chair scales in the presence of a qualified person (see Chapter 5.2)

9.1 Weighing



- ⇒ Start balance by pressing . The balance will carry out a segment test. The scales are ready for operation as soon as the weight display for “0.0kg“ has appeared.



- However, you can reset the weighing scale to zero by pressing the  key.

- ⇒ Seat the person in the centre of the scales.
- ⇒ Fold down (lower) the footrests and armrests. Support both feet of the weighed person on the footrests.
- ⇒ Place the forearms of the weighed person on the armrests.
- ⇒ Wait until stabilisation indicator is displayed , and then read the weighing result.
- ⇒ After weighing is finished, fold up (raise) the footrests and armrests again.



- If a person is heavier than the maximum weighing range, “OL” (overload) will appear on the display screen.

9.2 Taring

The tare weight of any preloads can be deducted by pressing a button so that the actual weight of the person is displayed in subsequent weighings.



(example)

⇒ Put object (such as towel or padding) on the seating pan.



⇒ Press , the zero display appears.

⇒ „NET” is shown at the bottom on the left.

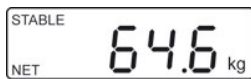

(example)

⇒ Seat person in the centre of the seat pan.
Wait until the standstill display „STABLE“ appears, then read the weighing result.





- When the balance is unloaded the saved taring value is displayed with negative sign.

- To delete the stored tare value, release scales and press .

9.3 HOLD function

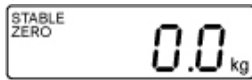
The balance has an integrated standstill function (mean value calculation). This allows correct weighing determination of a person although the latter is not keeping still on the seat surface.



⇒ Start balance by pressing . Wait for stability display „STABLE“ to appear.

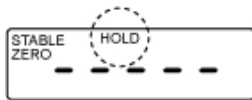

⇒ Press , in the display „-----“ will appear and the „HOLD“ symbol appears.

⇒ Seat person in the centre of the seat pan.

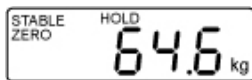

⇒ After a short time the stability display „STABLE“ appears and the weighing value of the person is displayed and „frozen“.

(Example)

After unloading the balance, the weighing value remains displayed for approx. 10 seconds, than the balance changes automatically into the weighing mode. The symbol „HOLD“ disappears.

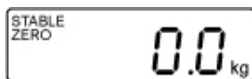

There is no average value calculation in the event of too much movement.

9.4 See second decimal point (not verified value)

Press  and hold for about 2 s whilst weighed result is being shown. The second decimal place will be shown for approx. 5 s.

9.6 Calculation of the Body Mass Index

You need to know a person's body height before you can calculate the BMI for that person. This should be known.



⇒ Start balance by pressing



⇒ Allow the person to step onto the centre of the weighing platform

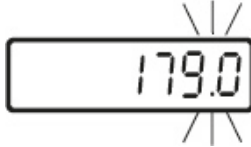

⇒ Wait for stability display „STABLE to appear.

⇒ Press . The most recently entered body height will be shown with the enable digit flashing.

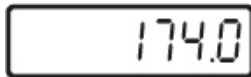

⇒ To enter body height, press the and key.

⇒ Confirm the value entered by .

The weighing scale is now in BMI mode and the BMI symbol will be appear and the kg display disappear. The calculated BMI value will be displayed.



⇒ Return to weighing mode using . The BMI symbol will disappear and the kg display will reappear.



- i**
- Reliable calculation of BMI is restricted to a body height of 100 cm to 200 cm and a weight of >10 kg.
 - If weighing has to take place under unsteady conditions, you can be stabilise the display by applying the Hold function.

9.6.1 Classification of BMI values

Weight classification for adults over 18 years of age using the BMI in accordance with WHO, 2000 EK IV and WHO 2004.

Categorie	BMI (kg/m ²)	Risk of diseases associated with overweight
Underweight	< 18.5	low
Normal weight	18.5 – 24.9	average
Overweight	≥ 25.0	
Pre-adipose	25.0 – 29.9	a bit high
Adipose degree I	30.0 – 34.9	high
Adipose degree II	35.0 – 39.9	up
Adipose degree III	≥ 40	very high

9.7 Automatic switch-off function „AUTO OFF“

The weighing scale will switch off automatically after the allotted time as long as neither the display unit nor the weighing surface is operated.

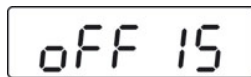

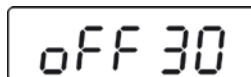

(example)



(example)

⇒ In weighing mode, press  and the first function **[F1 OFF]** will be displayed.

⇒ Press , the last saved time is displayed, for example, **[OFF 15]**

⇒ Press  repeatedly until the desired time is displayed, e.g. **[OFF 30]**

[OFF 0]	AUTO OFF - function disabled
[OFF 3]	Weighing system will be turned off after 3 min.
[OFF 5]	Weighing system will be turned off after 5 min.
[OFF 15]	Weighing system will be turned off after 15 min.
[OFF 30]	Weighing system will be turned off after 30 min.



⇒ Save selected time with , **[F1 OFF]** is displayed



⇒ Return to weighing mode using 

9.8 Display background illumination

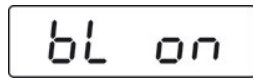
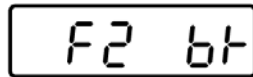



(example)



⇒ In weighing mode, press  and the first function **[F1 oFF]** will be displayed.

⇒ Press  repeatedly until **[F2 bk]** is shown.

⇒ Press , the last saved setting is displayed, for example **[bL on]**

⇒ To select the desired setting, press 

bL on	Continuous background lighting
bL off	Background illumination off
bL AU	Automatic background illumination on when weighing surface is loaded or key pressed.

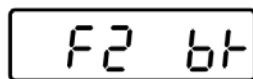

⇒ With  save select setting , **[F2 bk]** is displayed.



⇒ Return to weighing mode using 

10 Menu









Access to service menu „tCH“ is locked in verified balances.
To disable the access lock, destroy the seal and actuate the adjustment switch. For position of adjustment switch, see chap. 15.



Attention:

After destruction of the seal the weighing system must be re-verified by an authorised agency and a new verification wire/seal mark fitted before it can be reused for applications subject to verification.

10.1 Navigation in the menu

Call up menu	⇒ In weighing mode, press  and the first function [F1 OFF] will be displayed.
Select function	⇒ With help of  , the individual functions can be selected one after the other.
Change settings	⇒ Confirm selected function by  . The current setting will be displayed. ⇒ Select desired setting by  and confirm with  , the balance returns to the menu.
Exit menu/ Return to weighing mode	⇒ Press  and the scales will return to weighing mode.

10.2 Menu overview

Function	Settings	Description
F1 oFF Automatic cutout Auto Off	oFF 0*	Automatic shutdown off
	oFF 3	Automatic shutdown after 3 min
	oFF 5	Automatic shutdown after 5 min
	oFF 15	Automatic shutdown after 15 min
	oFF 30	Automatic shutdown after 30 min
F2 bk Background illumination of display	bl on	Back lighting for display on
	bl oFF	Display background illumination off
	bl AU*	Backlighting for display will come on automatically as soon as the weighing scale is operated.
F3 Str Subsequent tare value, locked in devices with type approval certificate.	Str on	Following tare ON
	Str oFF*	Following tare OFF
tCH Service menu	Pin	It display shows "Pin" adjust switch. Then press subsequently  ,  , 
P1 Spd Display speed	15*	Not documented
	30	
	60	
	7.5	
P2 CAL	Adjustment, see chap. 16.1	
P3 Pro	tri*	Not documented
	CoUnt	Not documented
	rESEt	Reset weighing scale to factory setting
	SEtGrA	Not documented

* default setting

11 Error messages

Display



Description

Zero range exceeded

(on start-up or when pressing the  key)

- Load on weighing pan
- Excess load, during zero setting of weighing scale
- Incorrect adjusting process
- Fault on load cell

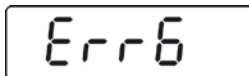

Value outside the A/D converter range

- Damaged weighing cell
- Damaged electronics



Unable to initialise zero point

- Measuring cell defective / overloaded
- Object on weighing pan / contact
- Transport safety device has not been removed
- Main board defective

Should other error messages occur, switch balance off and then on again. If the error message remains inform manufacturer.

12 Service, maintenance, disposal

12.1 Cleaning



Before any maintenance, cleaning and repair work disconnect the appliance from the operating voltage.

12.2 Cleaning / disinfecting

Clean weighing platform (such as seat) as well as casing with household detergents or commercially available disinfectants, e.g. 70% isopropanol. We recommend a disinfectant suitable for wiping disinfection. Please follow manufacturer's instructions.

Do not use abrasive or aggressive cleaners such as spirits or alcohol or similar as they might damage the high-quality surface.

To prevent cross-contamination (fungal skin infection) please observe the following time intervals for disinfection:

- Weighing plate before and after any measurement with direct skin contact
- When required:
 - Display
 - Touch-sensitive keyboard



Do not spray disinfectants onto appliance.

Make sure that disinfectant does not penetrate the interior of the appliance.

Remove dirt immediately.

12.3 Sterilisation

Sterilisation of the appliance is not allowed.

12.4 Service, maintenance

The appliance may only be opened by trained service technicians who are authorized by KERN.

We recommend regular verification of conformity with technical safety requirements (STK).

Disconnect the scales before opening.

12.5 Disposal

Disposal of packaging and appliance must be carried out by operator according to valid national or regional law of the location where the appliance is used.

13 Instant help

In case of a fault in the program sequence, the balance should be shortly switched off. The weighing process must then be restarted from the beginning.

Failure:

Possible causes:

The displayed weight does not glow.

- The balance is not switched on.
- The mains supply connection has been interrupted (mains cable not plugged in/faulty).
- Power supply interrupted.
- Rechargeable battery inserted incorrectly or empty.
- No rechargeable battery inserted.

The displayed weight is permanently changing

- Draught/air movement
- Table/floor vibrations
- The seating surface is in contact with foreign bodies or is not correctly positioned.
- Electromagnetic fields / static charging (choose different location/switch off interfering device if possible)

The weighing result is obviously incorrect

- The display of the balance is not at zero.
- Adjustment is no longer correct.
- Great fluctuations in temperature.
- The balance is on an uneven surface.
- Electromagnetic fields / static charging (choose different location/switch off interfering device if possible)

Should other error messages occur, switch balance off and then on again. If the error message remains inform manufacturer.

14 Verification

General introduction:

According to EU directive 2014/31/EU balances must be officially verified if they are used as follows (legally controlled area):

- a) For commercial transactions if the price of goods is determined by weighing.
- b) For the production of medicines in pharmacies as well as for analyses in the medical and pharmaceutical laboratory.
- c) For official purposes
- d) For manufacturing final packages
- e) Determination of mass in the practice of medicine that is, weighing patients for reasons of medical supervision during medical surveillance, examination and treatment.

In cases of doubt, please contact your local trade in standard.

Verification notes:

An EU type approval exists for balances described in their technical data as verifiable. If a balance is used where obligation to verify exists as described above, it must be verified and re-verified at regular intervals.

Re-verification of a balance is carried out according to the respective national regulations. For verification validity period, s. chap. 15.1.

The legal regulation of the country where the balance is used must be observed!



Verification of the balance is invalid without the seal.

The seal marks attached on balances with type approval point out that the balance may only be opened and serviced by trained and authorised specialist staff. If the seal mark is destroyed, verification loses its validity.

Please observe all national laws and legal regulations. In Germany a re-verification will be necessary.

Balances with obligation to verify must be taken out of operation if:

- **The weighing result of the balance is outside the error limit.** Therefore, in regular intervals load balance with known test weight (ca. 1/3 of the max. load) and compare with displayed value.
- **The reverification deadline has been exceeded.**

Position adjustment switch and seals:

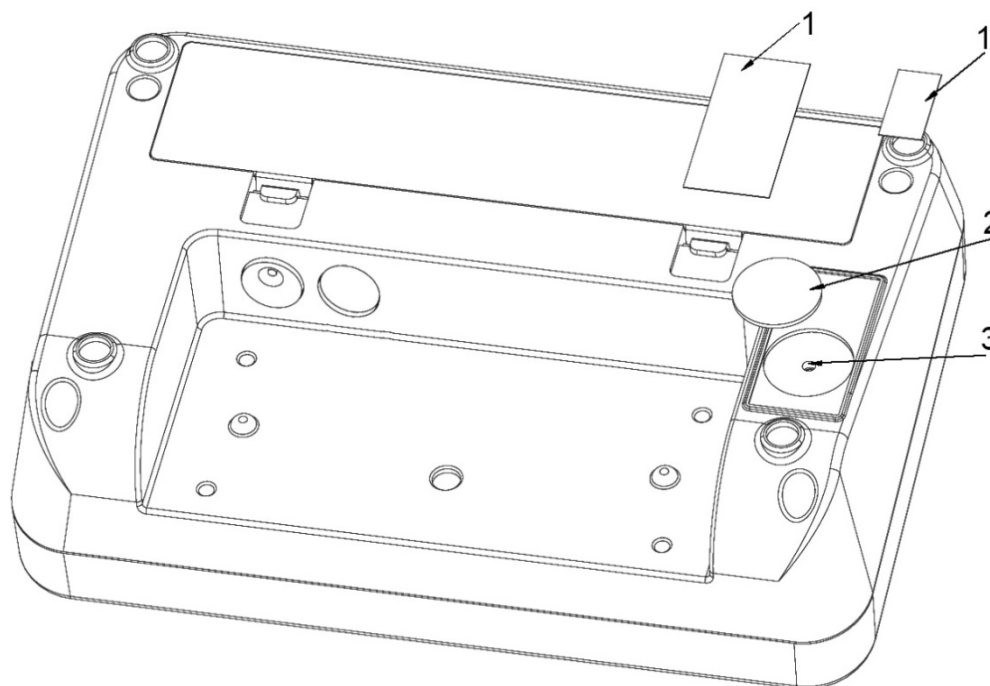

- 1. Self-destroying seal mark
- 2. Cover
- 3. Adjustment switch

14.1 Verification validity period (current status in G)

Personal scales (including chair and wheelchair scales) in hospitals	4 year
Personal scales, when not located in hospitals (for example, doctor's offices and nursing homes)	unlimited
Baby weighing scales and mechanical birth weight scales	4 year
Bed scales	2 year
Scales in dialysis stations	unlimited

Rehab clinics and health authorities are treated as hospitals.
(4 years of verification validity)

Not treated as hospitals (verification validity not limited) are dialysis stations, nursing homes and doctor's surgeries.

(Details derived from: „Information by the verification authority, weighing scales applied in medical use“)

15 Adjustment

As the acceleration value due to gravity is not the same at every location on earth, each display unit with connected weighing plate must be coordinated - in compliance with the underlying physical weighing principle - to the existing acceleration due to gravity at its place of location (only if the weighing system has not already been adjusted to the location in the factory). This adjustment process must be carried out for the first commissioning, after each change of location as well as in case of fluctuating environment temperature. To receive accurate measuring values it is also recommended to adjust the display unit periodically in weighing operation.



- Prepare the required adjustment weight. The adjustment weight to be applied depends on the capacity of a weighing scale, see chap. 1. Carry out adjustment as closely as possible to admissible maximum load of weighing scale. Information about test weights you will find in the internet under <http://www.kern-sohn.com>
- Observe stable environmental conditions. For warm-up time required for stabilisation see chpt 1.















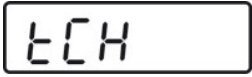





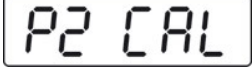

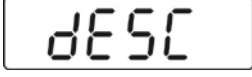
Access to service menu „tCH“ is locked in verified balances.

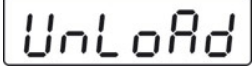

To disable the access lock, destroy the seal and actuate the adjustment switch. Position of the adjustment switch see chap. 15.

Attention:

After destruction of the seal the weighing system must be re-verified by an authorised agency and a new verification wire/seal mark fitted before it can be reused for applications subject to verification.

Procedure:

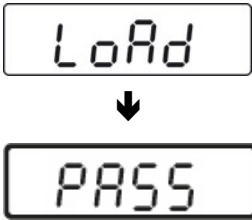
 <p style="text-align: center;">↓</p> 	<p>⇒ In weighing mode, press  repeatedly until [tCH] appears.</p>
	<p>⇒ Press , [Pin] is displayed</p>
	<p>Press ,  and  subsequently, [P1 SPd] will appear</p>
 <p style="text-align: center;">↓</p> 	<p>⇒ Press , „P2 CAL“ will be displayed</p> <p>⇒ Operate adjustment switch; for position see chap.15</p>
	<p>⇒ Press , [dESC] is displayed</p>
	<p>⇒ Press  repeatedly until [CAL] will be displayed.</p> <p>⇒ Confirm with , [UnLoAd] appears</p>
	<p>⇒ Ensure that there are no objects on the weighing pan.</p> <p>⇒ Wait for stability display "STABLE", then confirm with </p>
 <p>(example)</p>	<p>⇒ The size of the currently set adjustment weight will be displayed.</p> <p>To change, select the digit to be altered by , and the numerical value by .</p> <p>⇒ Confirm with , [LoAd] appears.</p>

	<ul style="list-style-type: none"> ⇒ Carefully place adjusting weight in the centre of the seating pan ⇒ Wait until stability display „STABLE“ appears ⇒ Confirm with  [PASS] is displayed.
	<p>After the adjustment the balance will carry out a self-test. Remove adjusting weight during selftest, balance will return into weighing mode automatically.</p> <p>An adjusting error or incorrect adjusting weight will be indicated by the error message; repeat adjustment procedure.</p> <p>An adjusting error or incorrect adjustment weight will generate an error message („Err 4“), repeat the adjustment process.</p>

16 Accessories

Article number	Product
MCC-A01	Bag

17 Printers

Connected printer shall be approved according to EN60950 (IEC60950) standard or equal standard.