



**KERN & Sohn GmbH**

Ziegelei 1  
D-72336 Balingen  
email: [info@kern-sohn.com](mailto:info@kern-sohn.com)

Phone: +49-[0]7433- 9933-0  
Fax: +49-[0]7433-9933-149  
Internet: [www.kern-sohn.com](http://www.kern-sohn.com)

# Operating instructions Baby weighing scale/ Toddler weighing scale

## KERN MBB

MBB 15K2DNM  
Version 3.3  
2019-05  
GB



MBB-NM-BA-e-1933

- D** Weitere Sprachversionen finden Sie online unter [www.kern-sohn.com/manuals](http://www.kern-sohn.com/manuals)
- BG** Други езикови версии ще намерите в сайта [www.kern-sohn.com/manuals](http://www.kern-sohn.com/manuals)
- DK** Flere sprogudgaver findes på websiden [www.kern-sohn.com/manuals](http://www.kern-sohn.com/manuals)
- EST** Muud keeleversioonid leiate Te leheküljel [www.kern-sohn.com/manuals](http://www.kern-sohn.com/manuals)
- E** Más versiones de idiomas se encuentran online bajo [www.kern-sohn.com/manuals](http://www.kern-sohn.com/manuals)
- GR** Άλλες γλωσσικές αποδόσεις θα βρείτε στην ιστοσελίδα [www.kern-sohn.com/manuals](http://www.kern-sohn.com/manuals)
- F** Vous trouverez d'autres versions de langue online sous [www.kern-sohn.com/manuals](http://www.kern-sohn.com/manuals)
- LV** Citas valodu versijas atradīsiet vietnē [www.kern-sohn.com/manuals](http://www.kern-sohn.com/manuals)
- FIN** Muut kieliversiot löytyvät osoitteesta [www.kern-sohn.com/manuals](http://www.kern-sohn.com/manuals)
- LT** Kitas kalbines versijas rasite svetainėje [www.kern-sohn.com/manuals](http://www.kern-sohn.com/manuals)
- GB** Further language versions you will find online under [www.kern-sohn.com/manuals](http://www.kern-sohn.com/manuals)
- RO** Alte versiuni lingvistice veți găsi pe site-ul [www.kern-sohn.com/manuals](http://www.kern-sohn.com/manuals)
- I** Trovate altre versioni di lingue online in [www.kern-sohn.com/manuals](http://www.kern-sohn.com/manuals)
- SK** Iné jazykové verzie nájdete na stránke [www.kern-sohn.com/manuals](http://www.kern-sohn.com/manuals)
- NL** Bijkomende taalversies vindt u online op [www.kern-sohn.com/manuals](http://www.kern-sohn.com/manuals)
- SLO** Druge jezikovne različice na voljo na spletni strani [www.kern-sohn.com/manuals](http://www.kern-sohn.com/manuals)
- P** Encontram-se online mais versões de línguas em [www.kern-sohn.com/manuals](http://www.kern-sohn.com/manuals)
- CZ** Jiné jazykové verze najdete na stránkách [www.kern-sohn.com/manuals](http://www.kern-sohn.com/manuals)
- PL** Inne wersje językowe znajdą Państwo na stronie [www.kern-sohn.com/manuals](http://www.kern-sohn.com/manuals)
- SE** Övriga språkversioner finns här: [www.kern-sohn.com/manuals](http://www.kern-sohn.com/manuals)
- H** A további nyelvi változatok a következő oldalon található: [www.kern-sohn.com/manuals](http://www.kern-sohn.com/manuals)
- HR** Druge jezične verzije su dostupne na stranici: [www.kern-sohn.com/manuals](http://www.kern-sohn.com/manuals)
- NO** Andre språkversjoner finnes det på [www.kern-sohn.com/manuals](http://www.kern-sohn.com/manuals)



# KERN MBB

Version 3.3 2019-05

## Operating instructions

### Baby weighing scale/ Toddler weighing scale

#### Table of Contents

<b>1</b>	<b>Technical Data</b> .....	<b>5</b>
<b>2</b>	<b>Declaration of conformity</b> .....	<b>6</b>
2.1	Explanation of the graphic symbols for medical devices .....	6
<b>3</b>	<b>Basic Information (General)</b> .....	<b>8</b>
3.1	Specific function.....	8
3.2	Proper use.....	9
3.3	Improper Use .....	9
3.4	Warranty .....	9
3.5	Monitoring of Test Resources.....	10
<b>4</b>	<b>Basic Safety Precautions</b> .....	<b>10</b>
4.1	Pay attention to the instructions in the Operation Manual .....	10
4.2	Personnel training .....	10
4.3	Preventing contamination .....	10
4.4	Appropriate use .....	10
<b>5</b>	<b>EMC guidance and manufacturer's declaration</b> .....	<b>11</b>
<b>6</b>	<b>Appliance overview</b> .....	<b>15</b>
<b>7</b>	<b>Overview of displays</b> .....	<b>16</b>
<b>8</b>	<b>Keyboard overview</b> .....	<b>17</b>
<b>9</b>	<b>Transportation &amp; Storage</b> .....	<b>18</b>
9.1	Testing upon acceptance .....	18
9.2	Packaging / return transport .....	18
<b>10</b>	<b>Unpacking, Setup and Commissioning</b> .....	<b>18</b>
10.1	Installation Site, Location of Use.....	18
10.2	Unpacking .....	19
10.3	Scope of supply.....	19
10.4	Assembly and erection .....	19
10.5	Assemble the wall bracket .....	20
10.6	Battery operation/ Rechargeable battery operation (optional).....	21
10.6.1	Battery operation.....	22
10.6.2	Rechargeable battery operation (optional) FOB-A08 .....	24
10.7	Connecting the power supply .....	26
10.8	Initial Commissioning .....	26
<b>11</b>	<b>Menu overview</b> .....	<b>26</b>
<b>12</b>	<b>Operation</b> .....	<b>27</b>
12.1	Weighing .....	27

12.2	<b>Taring</b> .....	27
12.3	<b>Hold function (Standstill function)</b> .....	28
12.4	<b>Toddler weighing scales</b> .....	29
12.4.1	<b>Assembly of toddler weighing scales</b> .....	29
13	<b>Error messages</b> .....	30
14	<b>Service, maintenance, disposal</b> .....	30
14.1	<b>Cleaning / disinfecting</b> .....	30
14.2	<b>Sterilisation</b> .....	31
14.3	<b>Service, maintenance</b> .....	31
14.4	<b>Disposal</b> .....	31
15	<b>Instant help</b> .....	31
16	<b>Verification</b> .....	32
16.1	<b>Adjustment</b> .....	32
16.2	<b>Adjustment controls and seals</b> .....	34
16.3	<b>Checking the balance verification settings</b> .....	35
16.3.1	Menu overview in service mode (adjustment switch in adjustment position) .....	36
16.4	<b>Navigation in the menu</b> .....	36
16.4.1	Exit menu and save.....	36
16.5	<b>Menu overview</b> .....	36
16.6	<b>Verification validity period (current status in G)</b> .....	39

# 1 Technical Data

<b>KERN (Type)</b>	<b>MBB 15K2DNM</b>
Model	MBB 15K2DM
Display	6-digit
Weighing range (max)	6 kg; 15 kg
Minimum load (Min)	40 g
Verification value (e)	2 g; 5 g
Reproducibility	2 g; 5 g
Linearity	2 g; 5 g
Display	LCD 24mm digit height
Recommended adjustment weight, (Class)	15 kg (M1)
Stabilization time (typical)	2 – 3 sec.
Warm-up time	10 min
Operating temperature	+ 5° C .... + 35° C
Storage temperature	- 20°C ... + 60°C
Humidity of air	max. 80 % (not condensing)
Electric Supply	Line adapter 12V / 500 mA or 15 V / 300 mA
	Battery operation 6 x 1.5V, size AA Operating life 50 h
Auto Off	After 3 min without load change, adjustable
Housing display unit (B x D x H) mm	210 x 110 x 45
Weighing pan (WxD) mm	560 x 295
Weight kg (net)	3.6
Calibrated in accordance with 2014/31/EU	grade III
Medical product in accordance with 93/42/EEC	Category I with measuring function
Rechargeable battery	Working life 50 h Loading time 14 h 7.2 V / 2000 mA

---

## 2 Declaration of conformity

---

To view the current EC/EU Declaration of Conformity go to:

[www.kern-sohn.com/ce](http://www.kern-sohn.com/ce)

**i** The scope of delivery for verified weighing balances (= conformity-rated weighing balances) includes a Declaration of Conformity. Solely these weighing balances are classified as medical devices.

### 2.1 Explanation of the graphic symbols for medical devices

All medical scales marked in this way meet the requirements of the following directives:

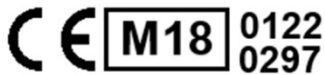

1. 2014/31/EU: Directive on non-automatic weighing instruments
2. 93/42/EC: Directive concerning medical devices



Scales marked in this way underwent the conformity assessment procedure according to Directive 2014/31/EU for scales belonging to 3rd accuracy class.

**SN WOC 17000100**

Designation of the serial number of every device, applied at the device and on the packaging

(Number as an example)



Identification of the manufacturing date of the medical product.

Year and month here as example



“Please note the accompanying documents“  
or “Observe operating instructions”



“Please note operating instructions”



“Please note operating instructions”



Identification of manufacturer of medical product including  
address

**Kern & Sohn GmbH**  
D-72336 Balingen, Germany  
[www.kern-sohn.com](http://www.kern-sohn.com)



“Electro-medical appliance“  
with attachment for type B

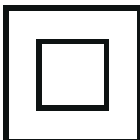

Device protection category II



Dispose of old appliances separately from your household  
waste!!

Instead, take them to communal collection points.

  
15 V DC / 300 mA or  
12 V DC / 500 mA

Display of supply voltage for scales with polarity display  
(Polarity and values serving as an example)



Supply voltage direct current



## Information

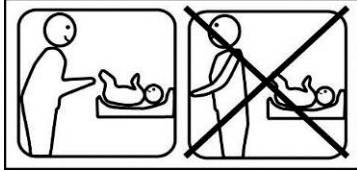

To prevent babies lying on the weighing pan from falling off the scale, they must be watched all the time. Please observe note on weighing pan!

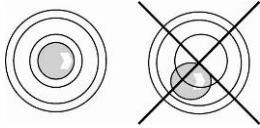

Level balance before use

---

### 3 Basic Information (General)

---



Weighing instruments have to be verified for the purposes stated below in accordance with Directive 2014/31/EU. Article 1, paragraph 4. “Determination of mass in the practice of medicine that is, weighing patients for reasons of medical supervision during medical surveillance, examination and treatment.”

#### 3.1 Specific function

- Indication**
- Determining the body weight in the medical practice area.
  - Operated as “non-automatic weighing instrument” which means that you have to carefully put the baby or the toddler in the centre of the weighing pan. Once a steady display value is shown, you can read the weight value.
- Contra-indication**
- No contraindication known



### 3.2 Proper use

These scales serve as a means of determining the weight of babies or toddlers in medical treatment rooms. The scales are suitable for recognizing, preventing and controlling illnesses.

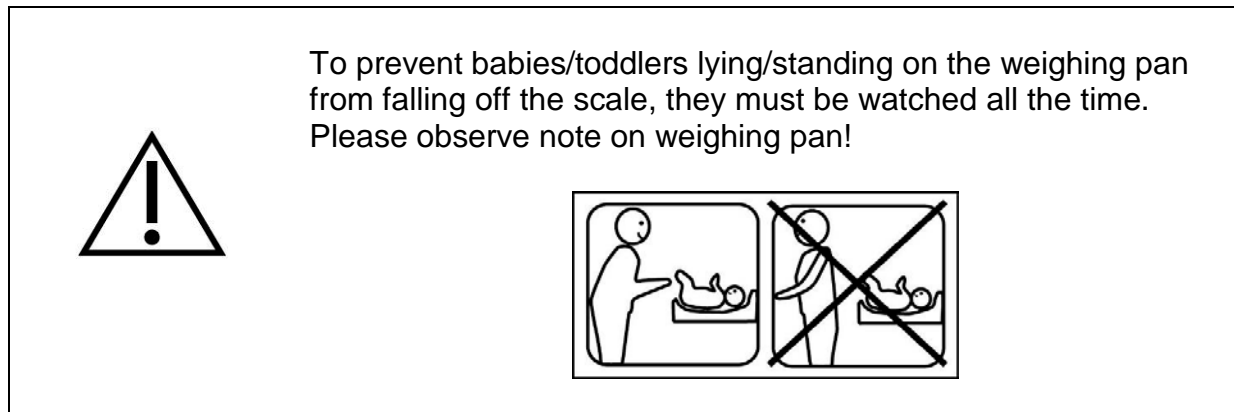

### 3.3 Improper Use

Do not use these scales for dynamic weighing processes.

Do not leave permanent load on the balance. This may damage the measuring system.

Impacts and overloading exceeding the stated maximum load (max) of the weighing pan, minus a possibly existing tare load, must be strictly avoided. This could cause damage to the balance.

Never operate balance in explosive environment. The serial version is not explosion protected. It should be noted that a flammable mixture of anesthetics and oxygen or laughing gas may occur.

The structure of the balance may not be modified. This may lead to incorrect weighing results, safety-related faults and destruction of the balance.

The balance may only be used according to the described conditions. Other areas of use must be released by KERN in writing.

### 3.4 Warranty

Warranty claims shall be voided in case

- Our conditions in the operation manual are ignored
- The appliance is used outside the described uses
- The appliance is modified or opened
- mechanical damage and damage caused by media, liquids,
- Natural wear and tear
- The appliance is improperly set up or incorrectly electrically connected
- The measuring system is overloaded
- Dropping the balance

### 3.5 Monitoring of Test Resources

In the framework of quality assurance the measuring-related weighing properties of the balances and, if applicable, the testing weight, must be checked regularly. The responsible user must define a suitable interval as well as type and scope of this test. Information is available on KERN's home page ([www.kern-sohn.com](http://www.kern-sohn.com)) with regard to the monitoring of balance test substances and the test weights required for this. In KERN's accredited DKD calibration laboratory test weights and balances may be calibrated (return to the national standard) fast and at moderate cost.



For balances with height measuring rods, we recommend a metrological examination of the accuracy of the height measuring rod, however, this is not mandatory as the determination of human body height involves rather large, intrinsic inaccuracies.

---

## 4 Basic Safety Precautions

---

### 4.1 Pay attention to the instructions in the Operation Manual

	⇒ Carefully read this operation manual before setup and commissioning, even if you are already familiar with KERN balances.	
--	---	--

### 4.2 Personnel training

The medical staff must apply and follow the operating instructions for proper use and care of the product.

### 4.3 Preventing contamination

To prevent cross-contamination (fungal skin infections, ...), clean the seating surface or weighing platform every time.

Recommendation: after a weighing procedure that could potentially result in contamination (e. g. after weighing that involves direct skin contact).

### 4.4 Appropriate use

- Always get on and off the medical scales in the presence of a qualified person (see Chapter 4.2).
- Before every use inspect the scales for any signs of damage.
- Maintenance and repeated verification  
Medical scales should be maintained and verified at regular intervals. (see Chapter 14.3)

## 5 EMC guidance and manufacturer's declaration

<b>Guidance and manufacturer's declaration-electromagnetic emissions</b>		
<p>The MBB-NM is intended for use in the electromagnetic environment specified below. The customer or the user of the MBB-NM should assure that it is used in such an environment.</p>		
<b>Emission test</b>	<b>Compliance</b>	<b>Electromagnetic environment-guidance</b>
RF emissions CISPR 11	Group 1	The MBB-NM uses RF energy only for its internal function. Therefore, its RF emissions are very low and are not likely to cause any interference in nearby electronic equipment.
RF emissions CISPR 11	Class B	The MBB-NM is suitable for use in all establishments, including domestic establishments and those directly connected to the public low-voltage power supply network that supplies buildings used for domestic purposes.
Harmonic emissions IEC 61000-3-2	Class A	
Voltage fluctuations /flicker emissions IEC 61000-3-3	Compliance	

### Guidance and manufacturer's declaration-electromagnetic immunity

The MBB-NM is intended for use in the electromagnetic environment specified below. The customer or the user of the MBB-NM; should assure that it is used in such an environment.

Immunity test	IEC 60601 test level	Compliance level	Electromagnetic environment-guidance
Electrostatic discharge(ESD) IEC 61000-4-2	± 6 kV contact ± 8 kV air	± 6 kV contact ± 8 kV air	Floors should be wood, concrete or ceramic tile. If floors are covered with synthetic material, the relative humidity should be at least 30%
Electrical fast transient/burst IEC 61000-4-4	± 2kV for power supply lines + 1kV for input/output lines	± 2kV for power supply lines Not applicable	Mains power quality should be that of a typical commercial or hospital environment.
Surge IEC 61000-4-5	± 1kV line(s) to line(s) ± 2kV line(s) to earth	± 1kV differential mode Not applicable	Mains power quality should be that of a typical commercial or hospital environment.
Voltage Dips, short interruptions and voltage variations on power supply input lines IEC 61000-4-11	<5% UT(>95% dip in UT) for 0,5 cycle 40% UT(60% dip in UT) for 5 cycles 70% UT(30% dip in UT) for 25 cycles <5% UT(>95% dip in UT) for 5 s	<5% UT(>95% dip in UT) for 0,5 cycle 40% UT(60% dip in UT) for 5 cycles 70% UT(30% dip in UT) for 25 cycles <5% UT(>95% dip in UT) for 5 s	Mains power quality should be that of a typical commercial or hospital environment. If the user of the MBB-NM requires continued operation during power mains interruptions, it is recommended that the MBB-NM be powered from an uninterruptible power supply or a battery.
Power frequency(50/60 Hz) magnetic field IEC 61000-4-8	3 A/m	3 A/m	The MBB-NM_power frequency magnetic fields should be at levels characteristic of a typical location in a typical commercial or hospital environment.

NOTE: UT is the a.c. mains voltage prior to application of the test level.

**Guidance and manufacturer's declaration-electromagnetic immunity**

The MBB-NM is intended for use in the electromagnetic environment specified below. The customer or the user of the MBB-NM should assure that it is used in such an environment.

Immunity test	IEC 60601 test level	Compliance level	Electromagnetic environment-guidance
Conducted RF IEC 61000-4-6	3 Vrms 150 KHz to 80 MHz	3 Vrms	<p>Portable and mobile RF communications equipment should be used no closer to any part of the MBB-NM; including cables, than the recommended separation distance calculated from the equation applicable to the frequency of the transmitter.</p> <p><b>Recommended separation distance:</b>  <math>d = 1,2 \sqrt{P}</math>  <math>d = 1,2 \sqrt{P}</math> 80MHz to 800 MHz  <math>d = 2,3 \sqrt{P}</math> 800MHz to 2,5 GHz</p> <p>Where <math>P</math> is the maximum output power rating of the transmitter in watts (W) according to the transmitter manufacturer and <math>d</math> is the recommended separation distance in metres (m).</p>
Radiated RF IEC 61000-4-3	3 V/m 80MHz to 2,5 GHz	3 V/m	<p>Field strengths from fixed RF transmitters, as determined by an electromagnetic site survey<sup>a</sup>, should be less than the compliance level in each frequency range<sup>b</sup>.</p> <p>Interference may occur in the vicinity of equipment marked with the following symbol:</p> 

NOTE1 At 80 MHz and 800 MHz, the higher frequency range applies.

NOTE2 These guidelines may not apply in all situations. Electromagnetic propagation is affected by absorption and reflection from structures, objects and people.

- a Field strengths from fixed transmitters, such as base stations for radio (cellular/cordless) telephones and land mobile radios, amateur radio, AM and FM radio broadcast and TV broadcast cannot be predicted theoretically with accuracy. To assess the electromagnetic environment due to fixed RF transmitters, an electromagnetic site survey should be considered. If the measured field strength in the location in which the MBB-NM is used exceeds the applicable RF compliance level above, the MBB-NM should be observed to verify normal operation. If abnormal performance is observed, additional measures may be necessary, such as re-orienting or relocating the MBB-NM.
- b Over the frequency range 150 kHz to 80 MHz, field strengths should be less than 3 V/m.

**Recommended separation distance between portable and mobile RF communications equipment and the MBB-NM**

The MBB-NM is intended for use in an electromagnetic environment in which radiated RF disturbances are controlled. The customer or the user of the MBB-NM can help prevent electromagnetic interference by maintaining a minimum distance between portable and mobile RF communications equipment (transmitters) and the MBB-NM as recommended below, according to the maximum output power of the communications equipment.

Rated maximum output power of transmitter W	Separation distance according to frequency of transmitter m		
	150 kHz to 80 MHz $d = 1.2\sqrt{P}$	80 MHz to 800 MHz $d = 1.2\sqrt{P}$	800 MHz to 2,5 GHz $d = 2.3\sqrt{P}$
0.01	0.12	0.12	0.23
0.1	0.38	0.38	0.73
1	1.2	1.2	2.3
10	3.8	3.8	7.3
100	12	12	23

For transmitters rated at a maximum output power not listed above, the recommended separation distance  $d$  in metres (m) can be estimated using the equation applicable to the frequency of the transmitter, where  $p$  is the maximum output power rating of the transmitter in watts (W) according to the transmitter manufacturer.

NOTE1 At 80 MHz and 800 MHz, the separation distance for the higher frequency range applies.  
NOTE2 These guidelines may not apply in all situations. Electromagnetic propagation is affected by absorption and reflection from structures, objects and people.

---

## 6 Appliance overview

---

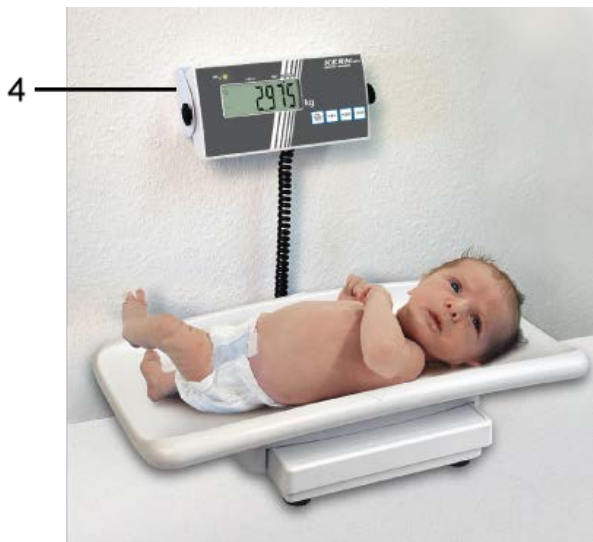

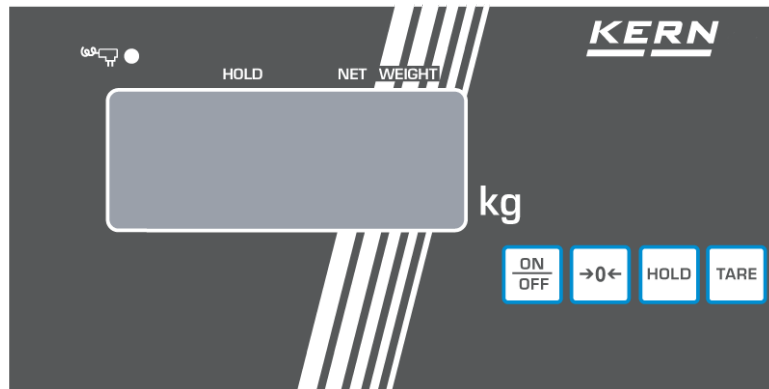

1. Weighing pan
2. Bubble level
3. Display unit
4. Wall bracket
5. Toddler weighing scales

## 7 Overview of displays



MBB 15K2DNM





Display	Designation	Description
→0←	Zeroing display	Should the balance not display exactly zero despite empty scale pan, press the  button. Your balance will be set to zero after a short standby time.
○	Stability display	Scales are in a steady state
	Power supply connected	Illuminates in the event of power supply via mains adaptor
HOLD	HOLD function active	Hold/Save function active
▲	NET	Net weight will be displayed
▲	WEIGHT	Current weight value will be displayed
▲		



---

## 8 Keyboard overview

---

Button	Designation	Function
	ON/OFF-switch	Turn on/off
	Zero setting key	Balance will be reset to 0.0 kg. Possible up to max. 2% of maximum load for verified scales or 2 % or 100% of maximum load for all other scales (selectable via menu)
	HOLD button	Hold function/Calculation of a stable weight value
	TARE button	Tare balance

---

## 9 Transportation & Storage

---

### 9.1 Testing upon acceptance

When receiving the appliance, please check packaging immediately, and the appliance itself when unpacking for possible visible damage.

### 9.2 Packaging / return transport



- ⇒ Keep all parts of the original packaging for a possibly required return.
- ⇒ Only use original packaging for returning.
- ⇒ Prior to dispatch disconnect all cables and remove loose/mobile parts.
- ⇒ Reattach possibly supplied transport securing devices.
- ⇒ Secure all parts such as the weighing pan, power unit etc. against shifting and damage.

---

## 10 Unpacking, Setup and Commissioning

---

### 10.1 Installation Site, Location of Use

The balances are designed in a way that reliable weighing results are achieved in common conditions of use. You will work accurately and fast, if you select the right location for your balance.

#### On the installation site observe the following:

- Place scales on a stable, even surface
- Avoid extreme heat as well as temperature fluctuation caused by installing next to a radiator or in the direct sunlight;
- Protect the balance against direct draughts due to open windows and doors;
- Avoid jarring during weighing;
- Protect the balance against high humidity, vapors and dust;
- Do not expose the device to extreme dampness for longer periods of time. Non-permitted condensation (condensation of air humidity on the appliance) may occur if a cold appliance is taken to a considerably warmer environment. In this case, acclimatize the disconnected appliance for ca. 2 hours at room temperature.
- Avoid static charge of the balance and of the person to be weighed.
- Avoid contact with water.

Major display deviations (incorrect weighing results) may be experienced should electromagnetic fields (e.g. due to mobile phones or radio equipment), static

electricity accumulations or instable power supply occur. In that case, the location must be changed.

## 10.2 Unpacking

Remove the individual components of the balance or the complete balance from the packaging with care and install at the intended location. When using the power pack, ensure that the power cable does not produce a risk of stumbling.

## 10.3 Scope of supply

- Balance
- Power unit (in conformity with EN 60601-1)
- Wall bracket
- Operating instructions

## 10.4 Assembly and erection

Make sure that the weighing pan/weighing plate is exactly horizontal.

Set the adjustable rubber feet of the baby scale in such a way that the air bubble inside the spirit level (on the right next to the cable outlet to the control unit) is in the centre.

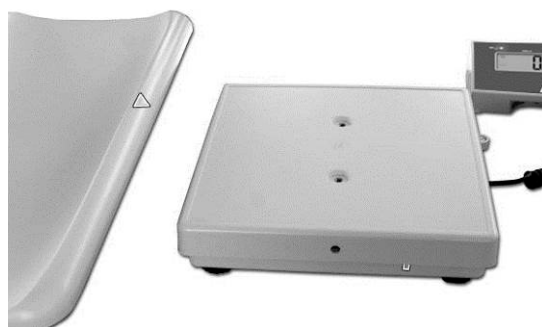
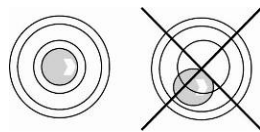

1. Push the front of the weighing pan (arrow) up to the stop across the weighing platform.



2. Screw in the locking screw at the bottom of the weighing pan into the mount.



3. Then screw in the corresponding locking screw to achieve a tight fit.



4. Use the supplied knurled screws to attach the wall bracket to the terminal.

### 10.5 Assemble the wall bracket

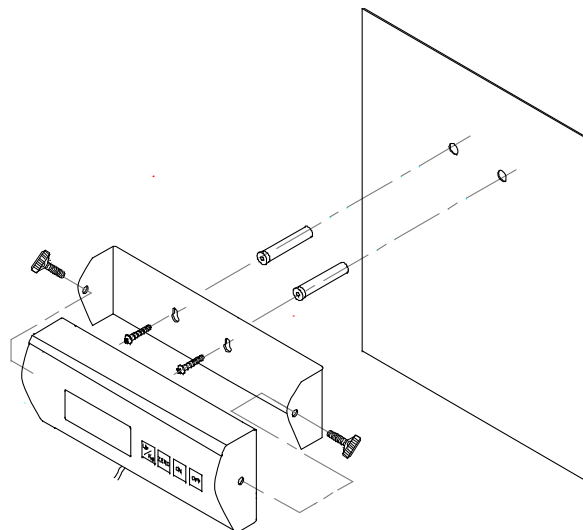

## 10.6 Battery operation/ Rechargeable battery operation (optional)

On models where the back of the display unit is not directly accessible, remove the two black rotary knobs from both sides of the display unit in order to open the battery compartment and remove the display unit from the holder. Remove battery cover from under the display unit. Insert 6 x 1.5V AA batteries into the holder. Replace battery cover and screw the display unit back into the holder using the black rotary knobs.

In order to save the battery, the balance switches automatically off after 3 minutes without weighing. Further shutdown times can be set in the Menu (Function "A.OFF"), see Section 11.



Connection **CN 4** for  
batteries (AA x 6)

Connection **CN 3** for  
rechargeable battery

## 10.6.1 Battery operation

⇒ Lift-off the battery cover on the back of the display unit

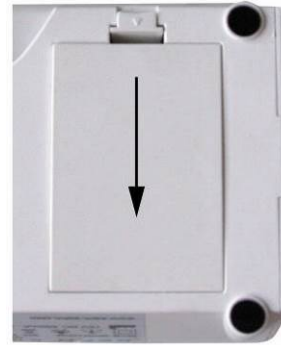

⇒ Carefully take out the battery holder (1)



⇒ Insert 6 batteries (AA).  
**Ensure that the batteries are inserted in the correct direction**



- ⇒ Insert battery holder with the inserted batteries into the display unit  
**Ensure that the cables are not squeezed**



- ⇒ Close the battery cover

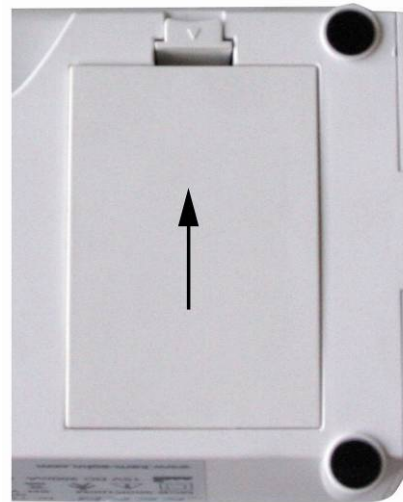

If the batteries are run down, "LO" appears in the display. To turn off scales, press the  button and immediately change the batteries.  
If the balance is not used for a longer time, take out the batteries and store them separately. Leaking battery liquid could damage the balance.

## 10.6.2 Rechargeable battery operation (optional) FOB-A08

When an optional rechargeable battery is used, proceed as follows:

On models where the back of the display unit is not directly accessible, remove the two black rotary knobs from both sides of the display unit in order to open the battery compartment and remove the display unit from the holder.

⇒ Lift-off the battery cover on the back of the display unit

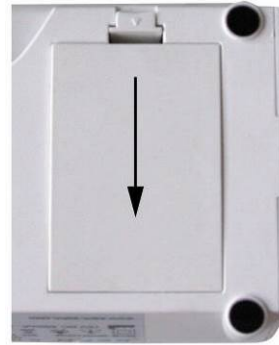

⇒ Carefully take out the battery holder (1)

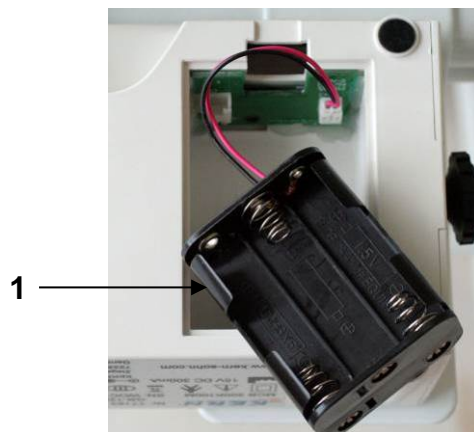

⇒ Carefully pull-out plug (2) from the connection **CN 4** (3)

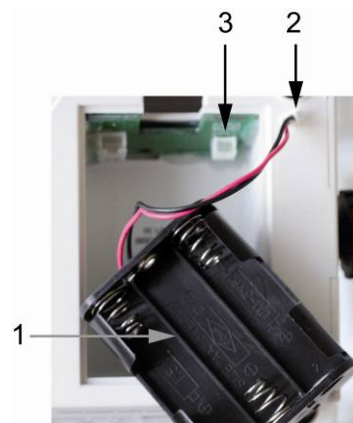



- ⇒ Carefully insert the rechargeable battery block and insert plug into connection **CN 3**  
**Ensure that the cables are not squeezed**



- ⇒ Close the battery cover

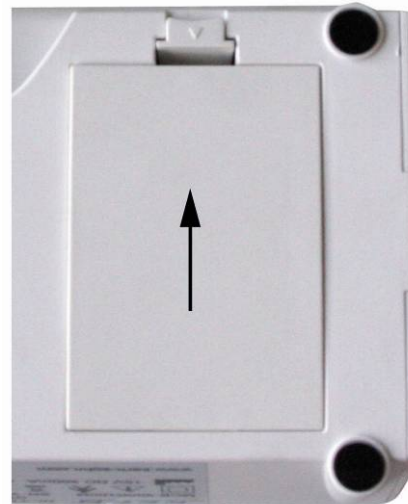

If the rechargeable battery is exhausted, „LO“ is displayed. The rechargeable battery is loaded via the provided plug-in power supply unit (loading time 14 h for a complete loading). If the balance is not used for a longer time, take out the rechargeable battery and store it separately. Leaking liquid could damage the balance.

## 10.7 Connecting the power supply







- Power is supplied by the external power unit which also serves to isolate the mains supply from the scale. The stated voltage value must be the same as the local voltage.
- Only approved genuine KERN power supply units may be used in compliance with Directive EN 60601-1.
- The scales can be supplied only by the delivered power supply. It is prohibited to supply it via a PC.

## 10.8 Initial Commissioning

In order to obtain exact results with the electronic balances, your balance must have reached the operating temperature (see warming up time chap. 1). During this warming up time the balance must be connected to the power supply (mains, accumulator or battery) and be switched on.

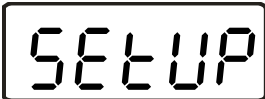
The accuracy of the balance depends on the local acceleration of gravity. The value of gravity acceleration is shown on the type plate.

## 11 Menu overview

-  ⇒ Start balance by pressing 
-  ⇒ Press  for 3 sec., "SETUP" will be displayed.
- ⇒ Select parameter by using  and , as described.
- ⇒ Confirm the selected parameter by pressing .

Function	Settings	Description
<b>SEtuP</b>		
<b>A. oFF</b> Automatic cutout Auto Off	180 s	Automatic shutdown after 3 min
	240 s	Automatic shutdown after 4 min
	300 s	Automatic shutdown after 5 min
	oFF	Automatic shutdown off
	120 s	Automatic shutdown after 2 min

<b>burr</b> Audio signal	on	Acoustic signal on
	oFF	Acoustic signal off
<b>End</b>		
Exit menu by pressing 		

## 12 Operation

### 12.1 Weighing



- ⇒ Start balance by pressing   
 The balance carry out a segment test, then the program version is displayed.  
 The scales are ready for operation as soon as the weight display for “0.0kg“ has appeared.



- The  button can be used to set the balance to zero at any time.

- ⇒ Put baby/toddler in the centre of the weighing pan/weighing plate.  
 ⇒ Wait for the rest position display , then read the weighing result.



- If the baby/toddler is heavier than the maximum weighing range, “Err” (overload) will appear on the display screen.

### 12.2 Taring

The tare weight of any preloads can be deducted by pressing a button so that the actual weight of the baby/toddler is displayed in subsequent weighings.

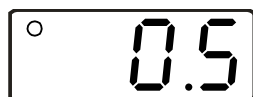

- ⇒ Put object (such as towel or padding) on the weighing pan.

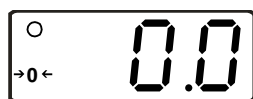

- ⇒ Press , the zero display appears.



- ⇒ Put baby on the weighing pan/weighing plate.  
Wait until the standstill display  appears, then read the weighing result.





- The balance is able to only store one taring value.
- When the balance is unloaded the saved taring value is displayed with negative sign.
- To delete the stored tare value, release scales and press .

### 12.3 Hold function (Standstill function)

The balance has an integrated standstill function (mean value calculation). This allows correct weighing determination of a baby/toddler although the latter is not keeping still on the scales.



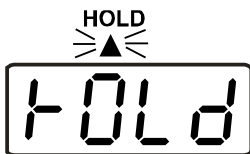

- ⇒ Start balance by pressing   
Wait for the rest position display .



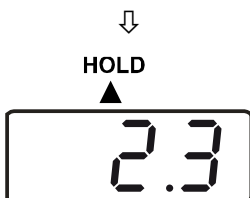

- ⇒ Put baby/toddler in the centre of the weighing pan/plate.



- ⇒ Press   
A triangle  starts to flash in the display, during this time the balance will record several measuring values and will then display the calculated average value.



- ⇒ By pressing the  button several times, the balance returns to the normal weighing mode.

- ⇒ Press the  button once more to repeat this function as often as required.



There is no average value calculation in the event of too much movement.

## 12.4 Toddler weighing scales



The balance can also be used as toddler weighing scales by removing the resting surface. The surface consists of robust ABS plastic material, hygienically to be defected.



### 12.4.1 Assembly of toddler weighing scales

A diagram showing the weighing pan being lifted from the scale. Two arrows point to the screws on the underside of the pan that need to be removed.	A diagram showing the weighing pan being shifted from the weighing plate. An arrow points to the pan, and another arrow points to the weighing plate.	Remove the opposite fastening screws.
A diagram showing the weighing pan being shifted from the weighing plate. An arrow points to the pan, and another arrow points to the weighing plate.		Shift the weighing pan from the weighing plate.

---

## 13 Error messages

---

### Display

### Description



#### Underload

Weight on weighing pan is too low.  
Please increase weight.  
If the error message remains inform manufacturer.



The weighing pan was bearing a load during start-up; unload weighing pan



#### Overload

Weight on weighing pan too heavy

---

## 14 Service, maintenance, disposal

---

### 14.1 Cleaning / disinfecting

Clean weighing platform (such as seat) as well as casing with household detergents or commercially available disinfectants, e.g. 70% isopropanol. We recommend a disinfectant suitable for wiping disinfection. Please follow manufacturer's instructions.

Do not use abrasive or aggressive cleaners such as spirits or alcohol or similar as they might damage the high-quality surface.

To prevent cross-contamination (fungal skin infection) please observe the following time intervals for disinfection:

- Weighing plate before and after any measurement with direct skin contact
- When required:
  - Display
  - Touch-sensitive keyboard



Do not spray disinfectants onto appliance.

Make sure that disinfectant does not penetrate the interior of the balance.

Remove dirt immediately.

## 14.2 Sterilisation

Sterilisation of the appliance not allowed.

## 14.3 Service, maintenance

The appliance may only be opened by trained service technicians who are authorized by KERN.

We recommend regular verification of conformity with technical safety requirements (STK).

Disconnect the scales before opening.

## 14.4 Disposal

Disposal of packaging and appliance must be carried out by operator according to valid national or regional law of the location where the appliance is used.

---

## 15 Instant help

---

In case of a fault in the program sequence, the balance should be shortly switched off. The weighing process must then be restarted from the beginning.

### Failure:

### Possible cause:

The displayed weight does not glow.

- The balance is not switched on.
- The mains supply connection has been interrupted (mains cable not plugged in/faulty).
- Check fuse of adapter / glowing green LED next to fuse
- Power supply interrupted.
- Batteries are inserted incorrectly or empty
- No batteries inserted.

The displayed weight is permanently changing

- Draught/air movement
- Table/floor vibrations
- The seat surface/weighing plate is in contact with foreign bodies or is not correctly positioned.
- Electromagnetic fields / static charging (choose different location/switch off interfering device if possible)

The weighing result is obviously incorrect

- The display of the balance is not at zero.
- Adjustment is no longer correct.
- Great fluctuations in temperature.
- The balance is on an uneven surface.
- Electromagnetic fields / static charging (choose different location/switch off interfering device if possible)

Should other error messages occur, switch balance off and then on again. If the error message remains inform manufacturer.

---

## 16 Verification

---

Verified scales bear a verification mark or one or more seals affixed by the Bureau of Standards or the manufacturer on or inside the housing which will self-destruct on removal. This makes it impossible to verify scales without damaging the seals.

### 16.1 Adjustment

Observe stable environmental conditions. A warming up time (see chapter 1) is required for stabilization.





In verified balances the adjustment function is switch locked. In order to carry out adjustments, the switch must be turned to adjustment position (centre position) (see chapter. 16.2).

#### Display

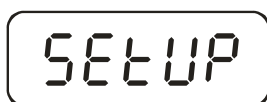

⇒ Start balance by pressing



⇒ Press  for approx. 3 sec, in the display appears „SETUP“, followed by „UNIT“

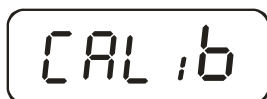



⇒ Press  repeatedly until “CAL 16” appears

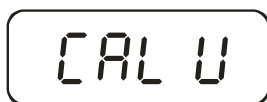



⇒ Press , „CAL U“ appears



⇒ Press , the appeared triangle ◀ must be located in the upper left part of the display.  
If it is not, press again .



⇒ Press  repeatedly until “CAL 0” appears.



⇒ Press ,  
the display will show a numeric value.

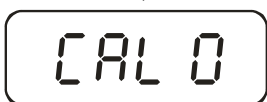

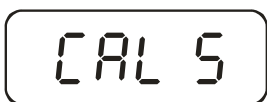

⇒ Then press ,  
“CAL 0” appears.



⇒ Press ,  
“CAL 5” appears.



⇒ Press   
Enter the required size of the adjustment weight (See Section 1, "Technical Data"):  
For this select the digit to be changed  
with  and the numeric value using .



⇒ Acknowledge by .

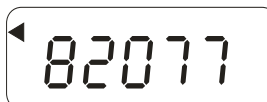

⇒ Place the adjustment weight carefully in the centre of the weighing pan and a numerical value will appear in the display.

⇒ Press , the adjustment process is started.



The balance will automatically return to Weighing mode upon successful completion of the adjustment and will display the weight of the adjustment weight.

Take away adjustment weight.



For verified scales, turn off the scales and move the adjustment switch back to verification position.

## 16.2 Adjustment controls and seals

After a verification the balance is sealed at the indicated positions.

**Verification of the balance is invalid without the "seal".**

**Position of the official seals:**

1. Rear



2. Battery compartment



### 3. Rear of platform

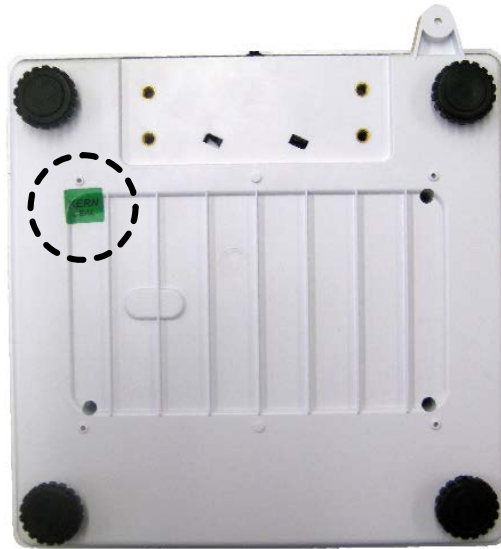

#### Position of the adjustment switch:

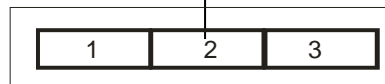
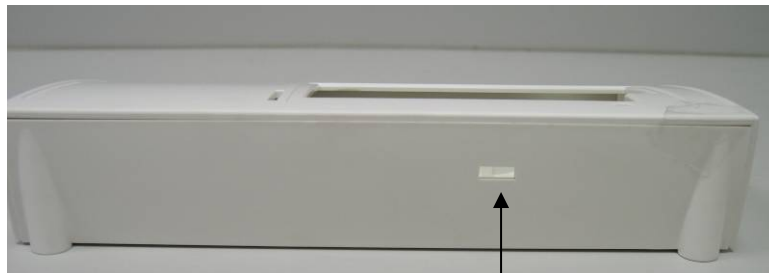

Position of the adjustment switch	State
1. to left	Not documented
2. concentric	Adjustment position - adjustment possible
3. to right	Verification position - adjustment locked

### 16.3 Checking the balance verification settings

For the adjustment function, the balance must be switched over to service mode. To achieve the effect, turn the adjustment switch to adjustment position.





In the service mode all parameters of the balance can be modified. The service parameters may not be modified, as this could damage the balance settings.

### 16.3.1 Menu overview in service mode (adjustment switch in adjustment position)



This overview is merely for checking the parameters set by the appropriate Bureau of Standards.

Changes may only be made to the parameters for the automatic shut-off function "R.OFF" and the audio signal "bUrr".

### 16.4 Navigation in the menu

- ⇒ With the balance switched on, keep the  button depressed for approx. 3 sec until "SETUP" is displayed followed by "9rAd".
- ⇒ Press the  button as often as necessary until the required function is displayed.
- ⇒ Press the  button to confirm the selected function. The first parameter will be displayed. Press the  button to select the required parameter and confirm by pressing the  button.

#### 16.4.1 Exit menu and save

- ⇒ Press the  button repeatedly until "END" appears.
- ⇒ Acknowledge by .

The balance returns automatically into weighing mode.

### 16.5 Menu overview

Function	Settings	Description
<b>SEtuP</b>		
<b>Unit</b>	on-off	Weighing unit kg
<b>Grad</b>	3000 d – 6000 d – 10000 d – 500 d – 1000 d – 1500 d - 2500 d - 2000 d	Partition steps, weighing range (max.) and readout (d)

<b>Ut.-d</b>	Full – S-Ut	Selection Single-range (Full)- / Multiple-range balance (S-Ut)
<b>FIIE</b>	Fast – Nor. - SLo	Filter: fast - normal - slow
<b>Auto 0</b>	0.25 d – 0.5 d – 1 d – 3 d - OFF	Auto-Zero Tracking
<b>Stab</b>	0.25 d – 0.5 d – 1 d – 3 d - off	Stabilisation range
<b>Orang</b>	2 Pct – 100 Pct.	Zero range: 2 % / 100 %
<b>Ould</b>	9 d – 2 Pct.	Overload range: 9 d / 2 %
<b>CALib</b>	CAL-U – CAL-0 CAL-5	Adjustment
<b>A.Off</b>	120s/180s/240s/ 300s/off	Automatic shutdown function
<b>burr</b>	on/off	Audio signal
<b>default</b>		Reset to default setting
<b>End</b>	Exit menu by pressing	

**Description:**

Unit	Weighing unit: kg
GrAd	Partition steps, weighing range (max.) and readout (d)
BL-d	Multi-range balance/ single-range balance selection
FULL	Single-range balance
S-BL	Multi-range balance
FILT	Filter: fast/ normal/ slow
Auto0	Auto Zero Tracking: 0.25d / 0.5d / 1d / 3d / OFF
StAb	Stabilisation range: 0.25d / 0.5d / 1d / 3d / OFF
OrAng	Zero range: 2% / 100%
OverLd	Overload range: 9d / 2%
CALib	Adjustment
ROFF	Auto off: 120 sec. / 180 sec. / 240 sec. / 300 sec. / OFF
bUrr	Audio signal: ON/OFF
dEFLt	Resetting to factory setting (Default setup)
End	Exit menu

### 16.6 Verification validity period (current status in G)

Personal scales in hospitals	4 year
Personal scales if not used in hospitals	unlimited
Baby weighing scales and mechanical birth weight scales	4 year
Bed scales	2 year
Wheelchair scales	2 year

Rehab clinics and local health authorities are treated as hospitals (4 years verification validity).

Not treated as hospitals (verification validity not limited) are dialysis stations, nursing homes and doctor's surgeries.

(Data source: "Bureau of Standards News, Weighing Instruments in Medicine")