

## FPT-H1

### Horizontal Test System

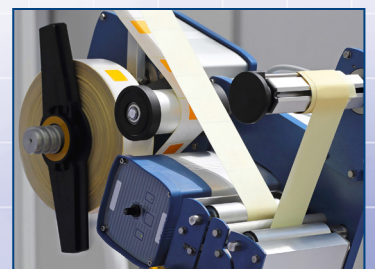

**Coefficients of friction, peel and tear**

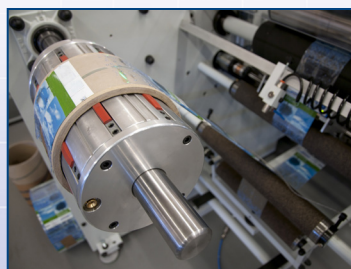

# Overview and features

The FPT-H1 is a dedicated horizontal tester, designed for testing to key international standards for coefficient of friction, peel and tear. Its sleek contemporary styling allied to its ease of use make it the instrument of choice for quality control professionals.

It is ideally suited for the packaging industry, and for manufacturers, converters or users of paper, board and plastic films. Further applications in coatings, floor coverings and textiles can be addressed with the FPT-H1.

## FPT-H1 for coefficient of friction testing

Designed for manufacturers, converters and end-users of film and sheet materials.

FPT-H1 is pre-programmed to perform static and dynamic coefficients of friction testing on a variety of materials.

- BS EN ISO 8295, ASTM D1894, ISO 15359, TAPPI T 549



## FPT-H1 for peel testing

Designed for the packaging, wrapping and laminating market. FPT-H1 is a convenient push-button peel tester to perform 90°, 180° or 'T'-peel tests.

- FINAT 1, 2 & 3, AFERA 5001, ASTM D3330, ASTM F88, ISO 8510-2 Part 2

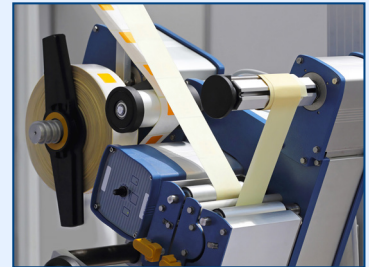

## FPT-H1 for tear testing

Designed for the plastic film, paper and textile industries. FPT-H1 assesses packaging material strength, welded joints, folds, creases and perforation lines.

- ASTM D1938-08, ISO 34-1, 6383-1, 12625-12, 13937 & 11897

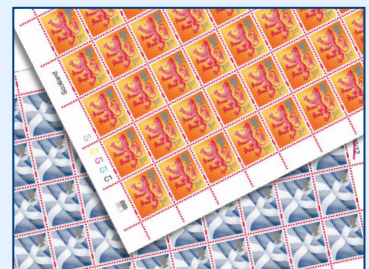

## Why choose Mecmesin?

Mecmesin has been designing, manufacturing and supplying precision force and torque testing systems and instruments since 1977. The FPT-H1 is the latest addition to our extensive range, designed specifically with input from packaging professionals.

With an unrivalled network of distributors in over 50 countries, we are able to provide local technical expertise with full training and after-sales support.

# Key features



## FPT-H1-i fully programmable tester

The FPT-H1-i is delivered with the powerful Emperor™ programming software (see page 8) and contains the pre-programmed routines found with the console version.



\* PC not supplied

# FPT-H1 for coefficient of friction testing

## A tester for manufacturers, converters, printers and end-users of film and sheet materials

The FPT-H1 is designed for quick and easy testing of static and dynamic coefficients of friction of a variety of materials. Test samples are secured to the plane bed and to a sled that is linked to a traversing crosshead driven by a precision ballscrew. Positioning and drawing of the sled is controlled by Emperor™ programs, which capture the test data, displaying the graph trace live, throughout the test run. At the end of each run the data are analysed, providing results for static and/or dynamic coefficients of friction, and allowing for sample comparison against quality standards if required.

### Key benefits

- knowing accurate coefficient of friction values optimises production line speeds
- avoid costly interruptions through tears and jams
- assess suppliers quickly to detect changing materials, finishes and conditions

Pre-loaded test standards: BS EN ISO 8295, ASTM D1894, ISO 15359 and TAPPI T 549 makes running a test as simple as touching a button

Spring action lower sample clamp holds securely for minimal sample handling

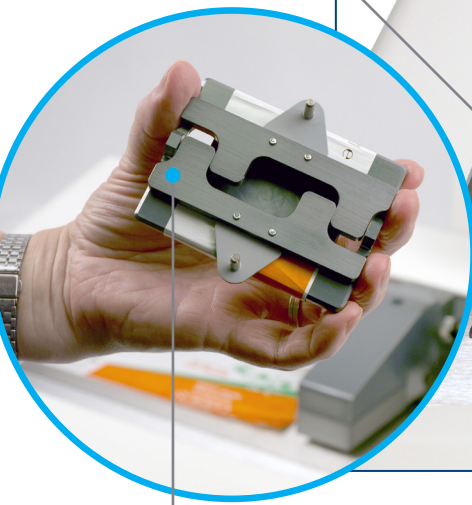

Magnetic catches grip sample ends quickly and securely, minimising any risk of touching the sample surface

200 gram sled with dimensions to suit all paper and plastic test standards

Interchangeable links meet requirements for all standard test methods, for most accurate measurement, including avoidance of stick-slip behaviour



Manufacturers

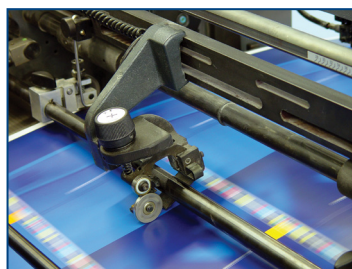

Converters



End-users

## ISO 15359 : Improving accuracy in paper and board coefficient of friction

In compliance with ISO 15359, the FPT-H1:

- » performs the entire standard test method with push-button operation
- » mechanises the placement of the sled with an integral lift
- » controls the static contact time between samples
- » raises the sled sample automatically at the end of each run
- » maintains a linear slide with friction-free guide rails.

friction-free guide rails maintain linear slide

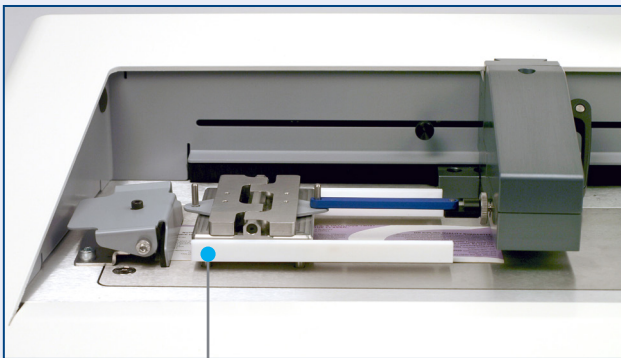

programmed sled placement and lifting

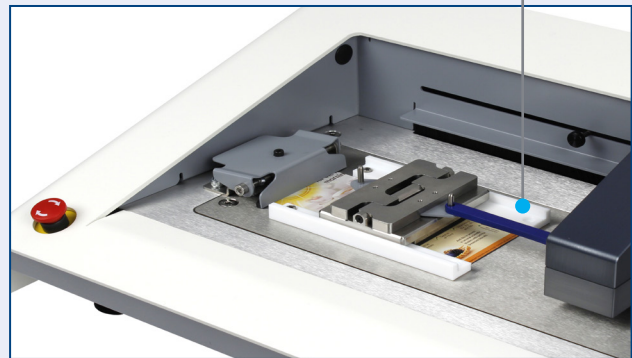

Uniquely, with the FPT-H1, you will:

- » eliminate inaccuracy due to surface asymmetry
- » avoid variance in results due to different operator behaviours
- » achieve more consistent and reliable friction values



Corrugated board



Rolls of film



Printed card

# FPT-H1 for peel testing

## All the convenience you need for a push-button peel tester, to perform 90°, 180° or T-peel tests

The FPT-H1 is also a horizontal peel tester, for measuring the peel characteristics of seals, seams and pressure-sensitive adhesive films, tapes and labels. For situations where versatility is required, the FPT-H1 can be fixtured for a variety of peel tests typical for the packaging, wrapping and laminating market, such as FINAT test methods 1, 2 and 3 for peel adhesion and release force testing of self-adhesive laminates and labels.

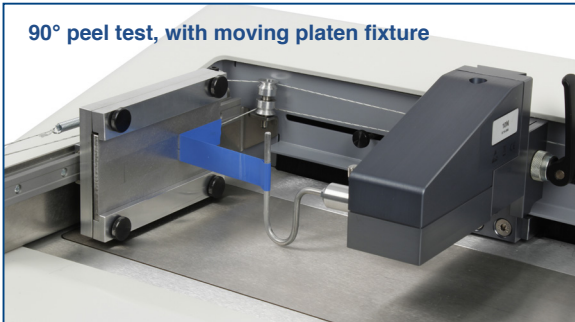

### Key benefits

- rapid throughput for quality testing packaging seals and closures
- reliable packaging design performance testing
- protect your brand perception through assured product consistency

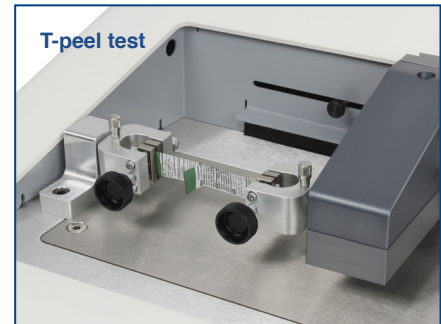

## Suitable for

- pressure sensitive adhesive tapes
- self-adhesive labels
- resealable openings
- welded packaging seals

## Peel standards supported by the FPT-H1

FINAT 1 and 2 : 180° and 90° peel adhesion at 300 mm per minute

FINAT 3 : low speed release force

AFERA 5001 : self-adhesive tapes

ASTM D3330 : pressure-sensitive tape

ASTM F88 : seal strength of flexible barrier materials

ISO 8510-2 Part 2 : 180 degree peel (flexible to rigid bonds)

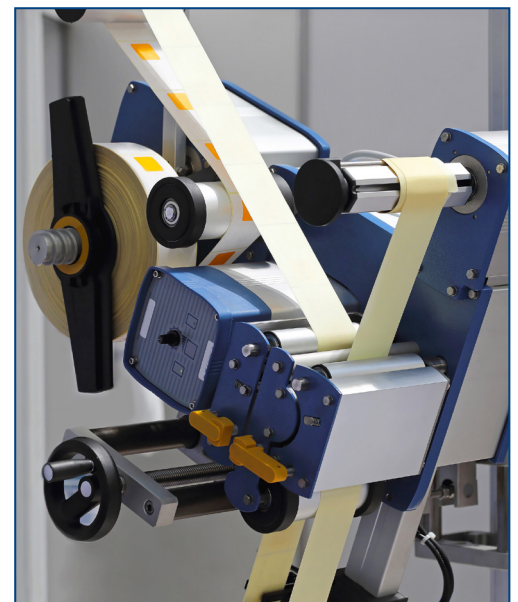

Production line labelling

# FPT-H1 for tear testing

## A tester for packaging material strength, welded joints, folds, creases and perforation lines

Tear testing is frequently a requirement alongside friction and peel. The single (trouser) tear method is commonly used for material strength, or to measure the strength of perforated lines, folds and creases. The FPT-H1 can be fixtured for single trouser tear tests, or for trapezoidal and Winkelmann/Graves style tests. It is suitable for a variety of materials, selecting an appropriately-rated interchangeable loadcell.



### Key benefits

- quality test product strength, in material choice, seal and seam manufacture
- quickly verify perforation line efficiency
- ensure customer retention through product performance consistency

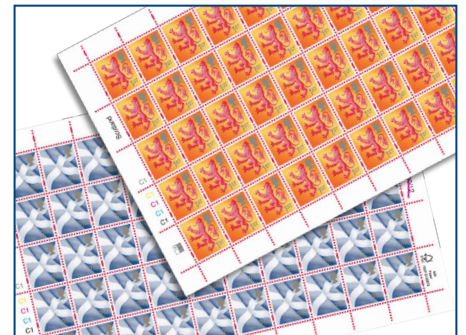

Sheets of stamps

## Suitable for

- plastic films and sheeting
- paper and card
- perforated closures
- perforated stamps, coupons and tickets
- fabric coverings and bindings

## Tear standards supported by the FPT-H1

- ASTM D1938-08 : tear-propagation resistance of plastic film and thin sheeting
- ISO 34-1 : tear resistance of rubber, vulcanized or thermoplastic films
- ISO 6383-1 : tear resistance of plastic films and sheeting
- ISO 12625-12 : tensile strength and efficiency of perforated lines
- ISO 13937 : tear properties of fabrics
- ISO 11897 : thermoplastic flexible film packaging, tear propagation edge folds



Tear-off tab

# The Power of Emperor™

Mecmesin's Emperor™ control, data acquisition and analysis software has been developed for sophisticated testing using a wide range of machines. It controls the entire test sequence, acquires the data measurement, performs calculations, returns and reports results.

## Pre-programmed convenience

The FPT-H1-xt is pre-loaded with Emperor™ programs for testing to a variety of print and packaging industry standards. Its touch-screen console provides convenient access to the library, programs are indicated by clear icons and run by a simple push-button interface.

- The test data are shown on screen as a real-time graph and a table displaying the appropriate results.
- The data and results can be exported to external systems for further analysis.



Touch-screen display to select the test and view clear results

## Create your own programs

If you have your own in-house test method, you can adapt or write your own programs for any kind of tensile or compressive test. Using Program Testing Mode, the true power of Emperor™ software becomes evident. The intuitive interface makes the entire test process easy to manage:

- Create and save a program for your test method for instant recall.
- Use in-depth data analysis to calculate results and set Pass/Fail criteria.
- Format the output for reporting, saving, and for auditing requirements.



## Performing a test

The Emperor™ user interface has the familiar Windows-style layout. Selecting and running a test from the library is simple, with commonly-used functions, such as graph analysis mode, review, export and print, all accessed from toolbars.

- Save all results for batch and material comparison over time.
- Tag samples and operators for traceability.
- Administrators restrict levels of access by operators to avoid accidental editing of test programs or results.



Select and run a program from the library

## Data analysis

Perform a wide range of calculations on your results using Emperor™, and print or save customised test reports. Evaluate characteristics in graph traces and compare samples against tolerance criteria for acceptability, highlighted by colour-coded Pass/Fail indicators.

- The video replay facility helps identify specific characteristics in a sample.
- Compare samples with each other visually; zoom in on the detail.
- Add further analysis methods using Excel with exported raw data.

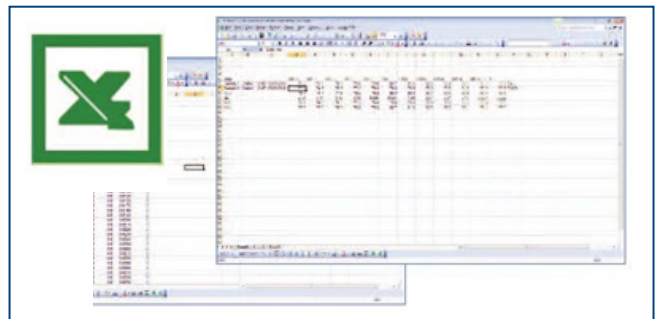

Data easily exported for further analysis

## Reporting and auditing

Produce tailored reports out of Emperor™, and export all data from a test, or just the calculation results. Maintain a complete quality audit trail of your suppliers' materials or for customers.

- Automatic export of data to Microsoft Excel® and SPC packages.
- Select standard reports, or create your own customised templates.
- Print directly to PDF.

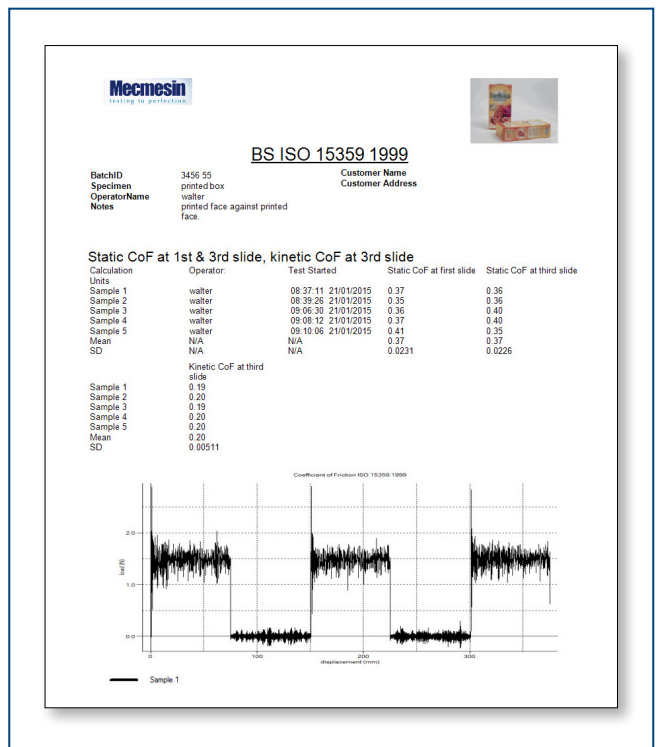

Customised reporting with company logo and sample image

# Dimensions

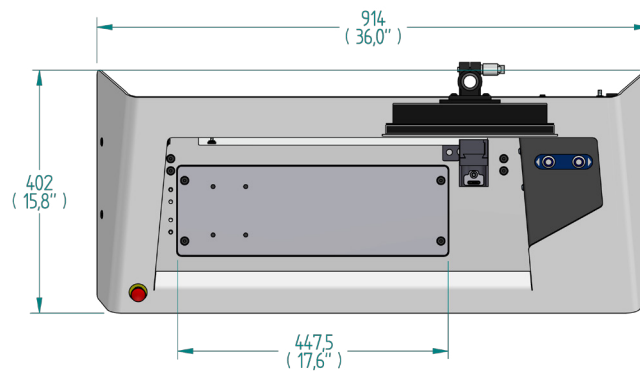
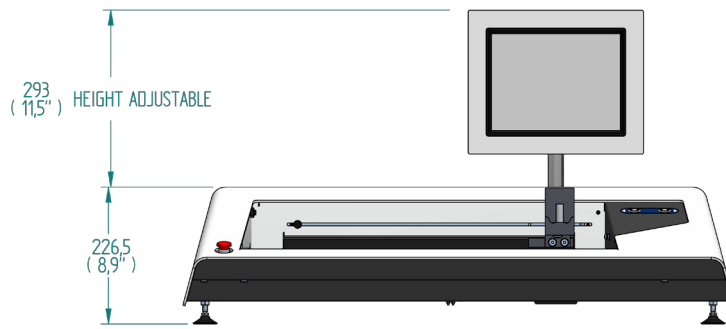

mm  
(inch)

## Order Numbers

Version	FPT-H1-xt (Touch-screen)		FPT-H1-i (PC-controlled)	
	UK	817-101-V01	UK	817-001-V01
EU	817-101-V02	EU	817-001-V02	
US	817-101-V03	US	817-001-V03	

\* To include ISO 15359 kit, use 817-102 or 817-002 prefix

Loadcell	FTP-H1 Loadcells	
	10 N loadcell	879-085
100 N loadcell	879-086	

Friction	Coefficient of friction sleds	
	200 g Sled TAPPI T 549 (neoprene facing)	432-633
	200 g Sled ASTM D1894, ISO 8295 (foam facing)	432-638
	ISO 15359 COF kit: sled, rails, lift (factory fitted)	432-639 *
	Heated platen (100°C)	432-640

Peel & Tear	90° Peel kit	432-620
	180° Peel kit	432-636
	Set of 5 float glass sample plates	432-651
	Set of 5 stainless steel sample plates	432-652
	25 mm vice grips, pair	432-642
	100 mm vice grips, pair	432-625

	Loadcell accuracy pulley kit	432-635
--	------------------------------	---------

# Specification

Load measurement	
Loadcell range	10 N, 100 N, (2.2 lbf, 22.5 lbf)
Load resolution	1:6500
Load accuracy	±0.1% of full scale output
Speed	
Speed, continuously variable	0.016 mm/s (1.0 mm/min) or (0.039 in/min) to 20 mm/s (1200 mm/min) or (47.2 in/min)
Speed accuracy	±0.2% of indicated
Test area	
Sled lowering rate (ISO 15359)*	3.0 mm/s ±2.0 mm/s (0.12 in/s ±0.079 in/s)
Crosshead height adjustment	30 mm (1.18")
Max. crosshead travel	275 mm (10.8")
Test surface	Stainless steel 304
Dimensions	
Height	226 mm (8.9") (console + 293 mm (11.5"))
Width	914 mm (36.0")
Depth	415 mm (16.3")
Weight	29.3 kg (64.6 lb) (25.6 kg (56.4 lb) without console)
Communications	
Digital I/O	6 input, 6 output
Ports	RS232 and USB
Network communications (FPT-H1-xt)	RJ45
	USB for external wireless connectivity
Power requirement	
Maximum power consumption	120 W
Supply voltage	230 V AC 50 Hz, or 110 V AC 60 Hz
Pneumatic connections (optional extra)	
Crosshead connection	4 mm fitting, 8 bar max. (116 psi)
Fixed connection	4 mm fitting, 8 bar max. (116 psi)
Environment	
Recommended temperature range	+10° to +35° C (50° to 95°F)
Noise emissions	Less than 70 dbA

\* optional feature

# Mecmesin

testing to perfection

## Mecmesin - a world leader in affordable force and torque testing solutions

Since 1977, Mecmesin has assisted thousands of companies achieve enhanced quality control in design and production. The Mecmesin brand represents excellence in accuracy, build, service, and value. In production centres and research labs worldwide, designers, engineers, operators, and quality managers endorse Mecmesin force and torque testing systems for their high performance across countless applications.

[www.mecmesin.com](http://www.mecmesin.com)



Algeria	Hungary	Philippines
Argentina	India	Poland
Australia	Indonesia	Portugal
Austria	Iran	Romania
Bangladesh	Ireland	Russia
Belgium	Israel	Saudi Arabia
Brazil	Italy	Serbia
Bulgaria	Japan	Singapore
Cambodia	Korea	Slovakia
Canada	Kosovo	Slovenia
Chile	Laos	South Africa
China	Latvia	Spain
Colombia	Lebanon	Sri Lanka
Costa Rica	Lithuania	Sweden
Croatia	Macedonia	Switzerland
Czech Republic	Malaysia	Syria
Denmark	Mexico	Taiwan
Ecuador	Morocco	Thailand
Egypt	Myanmar	Tunisia
Estonia	Netherlands	Turkey
Finland	New Zealand	UK
France	Norway	Uruguay
Germany	Paraguay	USA
Greece	Peru	Vietnam

The Mecmesin global distribution network guarantees your testing solution is rapidly delivered and efficiently serviced, wherever you are.



FS 58553

Mecmesin reserves the right to alter equipment specifications without prior notice. E&OE

DISTRIBUTOR STAMP

### Head Office Mecmesin Limited

w: [www.mecmesin.com](http://www.mecmesin.com)  
e: [sales@mecmesin.com](mailto:sales@mecmesin.com)

### North America Mecmesin Corporation

w: [www.mecmesincorp.com](http://www.mecmesincorp.com)  
e: [info@mecmesincorp.com](mailto:info@mecmesincorp.com)

### France Mecmesin France

w: [www.mecmesin.fr](http://www.mecmesin.fr)  
e: [contact@mecmesin.fr](mailto:contact@mecmesin.fr)

### Asia Mecmesin Asia Co., Ltd

w: [www.mecmesinasia.com](http://www.mecmesinasia.com)  
e: [sales@mecmesinasia.com](mailto:sales@mecmesinasia.com)

### Germany Mecmesin GmbH

w: [www.mecmesin.de](http://www.mecmesin.de)  
e: [info@mecmesin.de](mailto:info@mecmesin.de)

### China Mecmesin (Shanghai) Pte Ltd

w: [www.mecmesin.cn](http://www.mecmesin.cn)  
e: [sales@mecmesin.cn](mailto:sales@mecmesin.cn)