

Instruction manual

NCTE Read Out Unit



Thank you for choosing our product!

This instruction will help you at correct service and accurate exploitation of described device.

Information included in this instruction was prepared with high attention by our specialists and is description of the product without any responsibilities within the meaning of the commercial law. Based on the information should not be inferred a certain features or suitability for a particular application. This information does not release the user from the obligation of own judgment and verification. NCTE reserves the right to make changes without prior notice.

- Please read instructions below carefully and adhere to its recommendation
- Please pay special attention to the following characters:



CAUTION!

Not adhere to instruction can cause damage or impede the use of hardware or software.

Contents

- 1. Safety and installation rules..... 3
 - 1.1. Safety rules..... 3
 - 1.2. Mounting recommendation 3
- 2. Description..... 3
 - 2.1. Destination 3
 - 2.2. Front panel description 4
 - 2.3. Back panel description 4
 - 2.5.1 Power supply 5
 - 2.5.2 USB connector..... 5
 - 2.5.3 Relay outputs 6
 - 2.5.4 In1, In2 trigger inputs 6
 - 2.5.6 Sensor input 6
 - 2.5.7 Counter input..... 6
 - 2.5.8 Voltage input 0...10 V..... 7
- 3. Display – main window 7
- 4. Menu 8
 - 4.1. Config. Counter input – configuration of counter input 9
 - 4.2. Config. 0-10 V input – configuration of voltage input 9
 - 4.3. Comma position, Offset, Multiplier..... 10
 - 4.4. Config. PK outputs – configuration of relay outputs 11
 - 4.5. Trigger measurements 12
 - 4.6. General settings..... 13
 - 4.7. Memory card 15
 - 4.9 About program..... 15
- 5. Memory card 15
- 6. Password 16
- 7. PC program 16
- 8. Safety and installation rules..... 17

1. Safety and installation rules

1.1. Safety rules

- Before first use please refer to this instruction manual;
- Before first use please make sure that all cables were correctly connected,
- Please ensure proper working conditions compatible with device specification (e.g.: power supply, temperature, max. current consumption);
- Before making any modifications to wiring connections, turn off the power supply voltage.

1.2. Mounting recommendation

In environments with noise levels that are not known, it is recommended to follow measures described below to prevent any possible disturbance to the device:

- To ground or reset metal rails, on which are mounted instruments,
- Do not power devices on the same line as the device without a corresponding high power line filters;
- Please use screening of the supply, sensor and signal cables, with the ground for the screen should be connected only on one side, as close to the device;
- For motor power supply please use twisted pair cables, and if possible use a ferrite bead assumed on the wire;
- Please avoid of leading control cables (Signal) parallel or in close to electrical and power wires;
- Please avoid proximity to devices that generate high levels of electromagnetic interferences and/or pulse (high-power loads, the burden of the phase or power control group).

2. Description

2.1. Destination

The Read Out Unit is a multifunctional unit dedicated to force measurement from load cells. Except possibility of force measurement it has additional inputs for measuring linear displacement (input pulse, quadrature wave and voltage input 0..10 V) also velocity from counter input. This makes it possible to use this device in application, where linear measurement is required simultaneous with force measurement (e.g. tensile test the material in tension, etc.) Furthermore device has two programmable relay outputs and two outputs, which can be use for trigger measurements.

The device is equipped in graphic display and 4-button keyboard, so its configuration is simple and intuitive (to choose from English or Polish menu).

The box equipped in USB-communication interface, which allows in easy way for configuration and measurement acquisition form PC level (free application allows real-time record measured values, and save measurements to a file).

The box has seating for memory card FLASH (SD/SDHC), on which can be recorded measurements with frequency chosen by user (in 10 ms to 1 hour range). Built in real-time clock additionally enables acquisition of measurements with exact time and date.

Features

- Power supply 15...30 VDC;
- Cooperation with all analog NCTE sensors
- Counter input for incremental encoder or signals UP-DOWN/ STEP-DIRECTION type;
- 0..10 V input;
- Possibility of record min./max. value of measurement;
- Data acquisition with programmable period from 10 ms to 1 hour;
- Seating for memory cards FLASH (SD/SDHC) for measurements accumulating (save to file *.csv);
- 2 optically isolated inputs for external mode of trigger measurements;
- 2 relay outputs to control external devices;
- USB interface to communicate with PC;
- Front panel with buttons and graphic display;
- Robust aluminum housing – protection IP40.

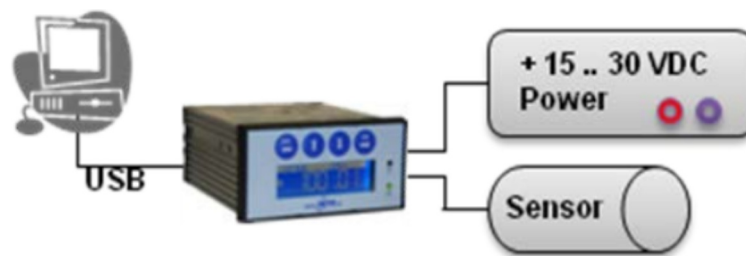

2.2. Front panel description

Function	Description
LEFT/ESC button	Buttons to navigate through the menu, acceptance and resignation of the selected function
UP button	
DOWN button	
RIGHT/OK button	
Display	Graphic display
Diode LED D1	Diode signaling active recording of measurements
Diode LED D2	Diode signaling frequency of recoding measurements

2.3. Back panel description

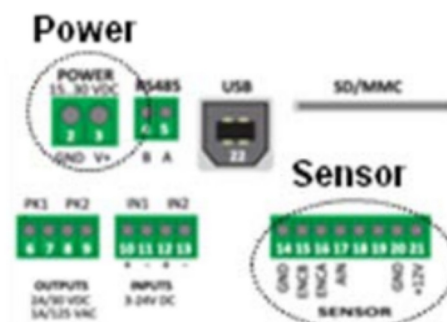

Description		Annotation
Non-connected	– 15..30 VDC	
V+	– 15..30 VDC	
GND	– 15..30 VDC	
COM 1	–1 relay	Relay outputs , max. current 1 A/125 VAC, 2 A/30 VDC
NO 1	–1 relay – output normally open	
COM 2	– 2 relay	
NO 2	–2 relay – output normally open	
IN 1 +	–WE1 optically isolated input– anode	Digital inputs: Low level <1 V High level 3...24 V
IN 1 -	–WE1 optically isolated input– cathode	
IN 2 +	–WE2 optically isolated input – anode	
IN 2 -	–WE2 optically isolated input – cathode	
GND	– unit weight of input 0..10V/encoder	
ENKA	–A counter input (encoder –A channel)	Quadrature input, TTL 5 V
ENKB	– B counter input (encoder–B channel)	
AIN	–0...10V input	
TENSV+	– power supply of force sensor (V+)	Minimal resistance of the bridge 200 Ω
TENSS+	– Signal + force sensor (S+)	
TENSS-	– Signal – force sensor (S-)	
TENSV-	– unit weight of force sensor (V-)	
	USB connector B type	
	SD/SDHC connector	

2.5.1 Power supply

The registration unit is powering with constant output voltage in range 15...30 VDC.



CAUTION!

Opposite polarization or passing max. voltage supply cause damage of device.

2.5.2 USB connector

The box equipped in USB connector B type. Connect the device to a PC is done using a standard USB cable A - B. By using the USB interface and the box - PC devices can be configured from a PC, data visualization on the graph, and record the measurements to a file in real time.

The box can work without connection with PC, as independent register-control device.



CAUTION!

USB connector is susceptible to noise in power supply and electromagnetic interference in industrial environments.

In case of having problems with connecting to the communication rate with the MD150A program use additional security features such as:

- MD150A Power supply from independent power supply.
 - Applying network filters in front of power supply unit powering indicator,
 - Applying USB connector length <1,5 m equipped in ferrite bead in the beginning and end of cable,
 - Applying optically isolated HUBs USB on the PC side.
- At strong interrupted conditions can occur situation, that communication will be impossible.

2.5.3 Relay outputs

The box equipped in two independent relay outputs PK1 and PK2 general purpose, low-load pins, software controlled.

2.5.4 In1, In2 trigger inputs

The device has two optically isolated inputs, which, depends on operating mode can be used to trigger or to stopping measurements.

Trigger mode	IN1 input	IN2 input
Continuous	-	-
WE1 pulse	Trigger of measurements	stopping measurements
WE1 level	Trigger/ stopping measurements	-
WE strain gauge	-	stopping measurements
WE counter	-	stopping measurements
WE 0...10 V	-	stopping measurements

High status for inputs means voltage application at 3...24 V range by min. 1 ms.

2.5.6 Sensor input

This input is used to connect sensor.

2.5.7 Counter input

This input is used to count external pulses. It receives pulses at 0-5 V (TTL) standard. For signals 24 V standard should be included series of signals ENKA, ENKB resistors 1,5 k (1...2,2 k).

This input can work at 3 modes:

- ENCODER mode – to cooperation with incremental encoder with quadrature wave output. It is recommended using encoders with TTL or line driver 5 V outputs.
- UP-DOWN mode – pulses given at A input reduce the counter, and on B input increases.
- STEP-DIRECTION mode – pulses given at B input reduce the counter (at no-signal on A input) or increases the counter (when on B input is given signal).



The box has also possibilities of reading the pulses velocity appearing on counter input. The velocity can be displayed at units:

- X/second (velocity refresh every 100 ms)
- X/minute (velocity refresh every 1 sec)
- X/hour (velocity refresh every 1 min)

2.5.8 Voltage input 0...10 V

This input is used to voltage signal connection 0...10 V, which can come from any sensor with 0...10 V output.

3. Display – main window

Main window of the read out unit allows to display information at several modes. Changing of displaying mode is possible online by  and  buttons. Default settings of display (after turn on power supply) can be changed in options (main settings -> set display). Pushing and holding ESC button  on chosen position by 3 sec enables fast access to function like tare sensor or pulses counter reset button.

Displaying information:

Torque

The display show the up-to-date value of the sensor signal to select units (**Nm** – Newton Meter, **Ncm** –Newton centimeter).

Pressing ESC - button  (> 3 ses) – tare indication of sensor signal.

Position

The display shows pulses quantity counted by counting input. This value can be scaled into mm, m, etc. introducing a multiplier values in the settings of the encoder input.

Pressing ESC - button  (> 3 sec) – reset pulses counter.

Torque / position / speed

The display shows:

- Value of sensor input
- Value of counter
- Value of speed

Data aquisition

The display shows:

- Current mode of trigger measurement
- Current sensor signal
- Max. sensor signal

Pressing ESC - button  (> 3 sec) – reset registered MAX value, stopping registration.

Date and time





The display shows:











- Current time [hour:minute:second]
- Current date [day-month-year]

Inputs and outputs

The display shows up-to-date state of inputs and outputs (1 – active, 0 – non-active). Inputs/outputs are presented at order (beginning from left): IN 1, IN 2, PK 1, PK 2

4. Menu

Entry into menu (from main window) is done by pressing  button. Shifting around menu up and down the list is done by  and  button, entry into deeper level menu follows after pressing  button, and the entrance to the next level the menu and exit the menu obtained by pressing  button.

Config. Counter input		Settings for load cell input		
 	Counter reset	Reset of pulses counter		
	Sensor type	A/B, A		
	Counts per revolution	0 ... 9999999		
	Auto reset	On, Off		
	Offset	-999.9999...+999.9999		
	Coefficient	-999.9999...+999.9999		
	Decimal point position	0.0000 .. 0.0		
	Speed units	Sec / Min / Hour		
Config. 0-10V inputs		Settings for analog 0...10 V		
 	Zero calibration	Removing of input voltage offset		
	Offset	-999.9999...+999.9999		
	Coefficient	-999.9999...+999.9999		
	Decimal point position	0.0000...0000		
	Units	Nm / Ncm		
	Filter [ms]	OFF, 20, 50, 100, 200, 250, 500, 750, 1000, 1250, 1500, 1750, 2000, 2500, 3000, 3500, 4000, 4500, 5000		
Trigger measurements		Settings way of trigger measurement registration		
 	Trigger mode	continuous / WE1 pulse / WE1 state / load cell input / encoder input / We. 0-10V		
	Start threshold	-9999.999...+9999.999		
	Stop threshold	-9999.999...+9999.999		
	Trigger period	10 ms, 50 ms, 100 ms, 200 ms, 500 ms, 1 s, 2 s, 5 s, 10 s, 30 s, 1 min, 5 min, 15 min, 30 min, 60 min		
	Auto reset	YES/NO		
Memory card		Memory card options		
	Information about card			
	Record on card	YES/NO		
Config. PK outputs		Settings for relay outputs PK1 and PK2		
 	PK1 output	Settings PK1 output		
		Source	Load cell input / encoder input / 0-10V input	
		Turn on threshold	-9999.999...+9999.999	
		Turn off threshold	-9999.999...+9999.999	
	PK2 output	Settings PK2 output		
		Source	Load cell input / encoder input / 0-10V input	
		Turn on threshold	-9999.999...+9999.999	
		Turn off threshold	-9999.999...+9999.999	
Global settings		Global settings of device		
 	Language selection	POLISH/ENGLISH		
	Set hour			
	Set date			
	Set display	Load cell input / counter input / input 0-10V load cell_encoder_0-10V / Registration / Date and hour / inputs and outputs / counter / counter- velocity		
	Set MODBUS address	Address MODBUS 1...254		
	Set MODBUS baudrate	velocity MODBUS 19200, 38400, 57600, 115200		
	Set password			
	Factory settings			
Device info				

4.1. Config. Counter input – configuration of counter input

It allows to setting parameters for counter input (A and B signals).

Counter reset

It enables to reset pulses counter from counter input.



Exit of reset function



Counter reset and exit of reset function

Input mode

It allows set counter input mode.

Available modes: **A-B** - keyboard mode (for encoder), **UP-DOWN** - mode **DIR-CLK** - step/direction mode. Precise description of modes is at chapter 2.5.7



Pressing cause exit function without change acceptance



Pressing cause change of mode



Pressing cause acceptance of choice and exit function

Velocity units

It enables set unit for velocity measurement (frequency) from counter input.

Available units: **sec** - pulses/second, **min** - pulse/minute, **hour** - pulses/hour.



Pressing cause exit function without change acceptance



Pressing cause change of mode



Pressing cause acceptance of choice and exit function

Comma position, Offset, Multiplier

Settings described at chapter 4.4

4.2. Config. 0-10 V input – configuration of voltage input

It allows set parameters for voltage input.

Input calibration

It allows remove voltage input offset.



Pressing cause exit function



Pressing cause acceptance of choice and exit function

Comma position, Offset, Multiplier

Settings described at chapter 4.4

4.3. Comma position, Offset, Multiplier

Values of load cell, encoder or voltage input can be freely calibrated by set multiplier and offset parameters according following formula:

$$\text{VALUE} = (\text{MEASUREMENT} \times \text{MULTIPLIER}) + \text{OFFSET}$$

Through that is possible to calculate the value of the voltage or encoder input to other units, eg. passed distance. For example using a linear potentiometer sensor with resistance or voltage output, the voltage can be converted directly on measured by sensor distance in mm.

Offset / Multiplier

It enables to set multiplier/ offset (range -999.9999...+999.999).



Pressing cause move cursor position to the left



Pressing cause:

- Increase/decrease parameter, when cursor is on value or on character
- Approval of position, when cursor is on OK position
- Resignation, if cursor is on CANCEL position



Pressing cause move cursor position to the right

Comma position

It allows set decimal place of displaying value.



Pressing cause exit function



Pressing cause move comma to the right or to the left



Pressing cause acceptance of choice and exit function

4.4. Config. PK outputs – configuration of relay outputs

It enables to set way of switch on/ off PK1/PK2 relay.

PK1/PK2 relay can be switch on/off after exceeding values switch on/off threshold, by value of fixed source, which can be: force sensor/ encoder/ voltage input. Drawing below shows way of switch on/off relay depends on thresholds value.

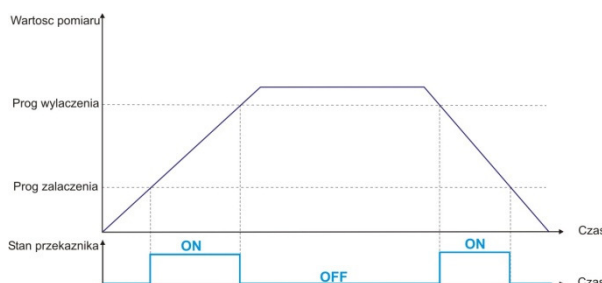

Source

It allows chose controlling signal „source" of switch on/off the relay.



Pressing cause exit function



Choosing trigger source



Pressing cause acceptance of choice and exit function

Switch on/off threshold

It allows to introduction value of switch on/off threshold of relay.



Pressing cause move cursor position to the left



Pressing cause:

- Increase/decrease parameter, when cursor is on value or on character
- Approval of position, when cursor is on OK position
- Resignation, if cursor is on CANCEL position



Pressing cause move cursor position to the right

4.5. Trigger measurements

It enables to set way of trigger measurements by devices at recording data on memory card and at registration minimal /maximal value.

Currently displayed values from load cell/ encoder/ voltage input on display and the status of relay outputs **are independent** of the setting trigger measurements.

Trigger modes

Setting trigger measurements mode. Available modes:

Continuous – measurement record on card is independent of WE1/WE2 inputs status, and signal inputs (strain gauge, encoder, voltage). Period of recording to card depends on parameter "**trigger period**".

WE1 pulse – beginning of measurement registration starts at giving high state for at least 1ms to **IN1** input. Stop recording measurements is fed to high status to **IN2** input. The period of record to the card depends on the parameter "**trigger period**".

- **WE status** – measurements are recorded, when at **IN1** input is high. When at **IN1** is low status registration is stopped. The period of record to the card depends on the parameter "**trigger period**".
- **Load cell input** – start recording measurements after exceeding the value of the load cell set "**start threshold**". Stop the measurement occurs when the measurement falls below the "**stop threshold**", or when the input **IN2** will be given a high state. The period of record to the card depends on the parameter "**trigger period**".
- **Encoder / 0-10V input**– registration starts after exceeding value of encoder/ voltage input setting "**start threshold**". Stop the measurement occurs when the measurement falls below the "**stop threshold**", or when the input **IN2** will be given a high state. The period of record to the card depends on the parameter "**trigger period**".



Pressing cause exit function



Choosing trigger mode



Choosing trigger mode



Pressing cause acceptance of choice and exit function

Start/ stop threshold

Settings values for start/stop thresholds of measurement registration. Active for modes: **load cell input/ encoder/ 0-10V input**.



Pressing cause move cursor position to the left



Pressing cause:

- Increase/decrease parameter, when cursor is on value or on character
- Approval of position, when cursor is on OK position
- Resignation, if cursor is on CANCEL position





Pressing cause move cursor position to the right

Trigger period (period measurements registration)

It allows set period, on which measurement data is recorded on memory card, and is updated max. value of load cell input. Available values :**10 ms, 50 ms, 100 ms, 200 ms, 500 ms, 1 s, 2 s, 5 s, 10 s, 30 s, 1 min, 5 min, 15 min, 30 min, 30 min**.







Pressing cause exit function

-  Choosing trigger mode
-  Choosing trigger mode
-  Pressing cause acceptance of choice and exit function

Auto reset

This function cause automatically counter reset from encoder input and reset indication form voltage input at beginning trigger measurement. Active for trigger modes: **WE1 pulse**, **WE1 status**, **load cell input**.

-  Pressing cause exit function
-  Turn on/off auto-reset function
-  Turn on/off auto-reset function
-  Pressing cause acceptance of choice and exit function

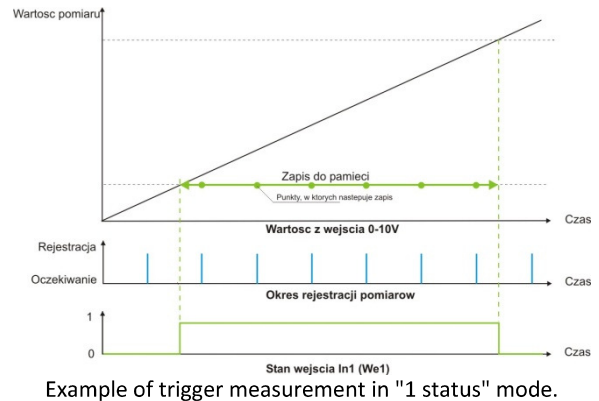
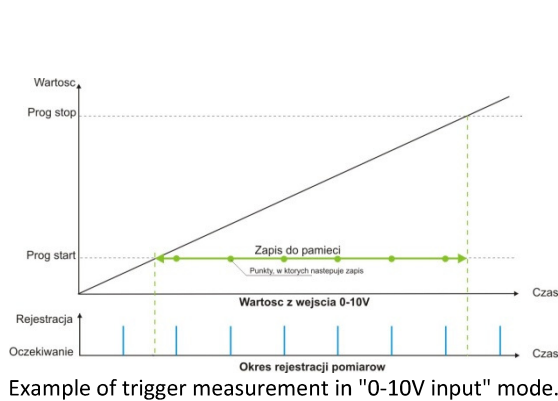





Regardless of chosen trigger mode, on memory always are recorded values of 3 measuring inputs (force value of load cell input, value of encoder input and voltage input).

4.6. General settings

Selection language

It allows choose language of device menu. Available languages: **POLISH/ ENGLISH**

-  Pressing cause exit function
-  Selection language
-  Selection language
-  Pressing cause acceptance of choice and exit function

Set hour

It enables set hour built-in clock.



Pressing cause move cursor position to the left



Pressing cause:

- Increase/decrease parameter, when cursor is on value or on character
- Approval of position, when cursor is on OK position
- Resignation, if cursor is on CANCEL position



Pressing cause move cursor position to the right

Set date

It allows set date built-in clock.



Pressing cause move cursor position to the left



Pressing cause:

- Increase/decrease parameter, when cursor is on value or on character
- Approval of position, when cursor is on OK position
- Resignation, if cursor is on CANCEL position



Pressing cause move cursor position to the right

Set display

It enables set default settings after turn on device power supply.



Pressing cause exit function



Chose settings



Pressing cause acceptance of choice and exit function

Set password

This function allows introduce protective password to device menu. Registration 0000 pass-word causes its turn-off.



Pressing cause move cursor position to the left



Pressing cause:

- Increase/decrease parameter, when cursor is on value or on character
- Approval of position, when cursor is on OK position
- Resignation, if cursor is on CANCEL position



Pressing cause move cursor position to the right

Default settings

This function cause reset all settings and set default settings of the device.



Pressing cause move cursor position to the left



Pressing cause:

- Increase/decrease parameter, when cursor is on value or on character
- Approval of position, when cursor is on OK position
- Resignation, if cursor is on CANCEL position



Pressing cause move cursor position to the right

4.7. Memory card

Info about card

It displays information about card size in MB, and quantity available memory.



Pressing cause back to menu

Record on the card

It allows turn on/off measurements record on memory card.



Pressing cause exit function



Pressing cause change position



Pressing cause acceptance of choice and exit function

4.9 About program

It shows information about name and version of the device.

5. Memory card

The box can record registered measurements on memory card, which seating is on back panel of the device. This card should be inserted as shown below. To compress / eject the card, use a thin object (such as a second card).

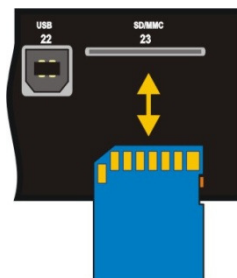

Registered data on memory card is record to a file name **data.txt** according to format below:

Date [dd-mm-rrrr]	Hour [hh:mm:ss]	Value of load cell input [cccc.dddd]	Value of encoder input [cccc.dddd]	Value of voltage input [cccc.dddd]
-------------------	-----------------	--------------------------------------	------------------------------------	------------------------------------

Eg.:

12-02-2010	13:14:36	00230.5400	14612.0000	00006.4500
12-02-2010	13:14:36	00230.5600	14612.0000	00006.4500
...
12-02-2010	13:16:26	00630.0000	19602.0000	00000.2200

Description:, dd- day, mm- month, rrrr- year, hh- hour, mm-minute, ss- second, c- complete part of measurement , d – decimal part of measurement.

The values are stored in the form such as shown on the display, but with a fixed number of decimal places.

6. Password

Introduction of password cause secure before entering the menu. When you enter the menu, should enter the previously set password. Valid session of entered password is 1 minute. After this time (if it were not for a minute no keys pressed on the device) entry to the menu will require a new password. Universal password for the box is 2491.

To turn on the password open general settings -> Set password, then set 0000 value.

7. PC program

The box registration unit can cooperate with the box-PC program, which allows to its configuration of PC level. This program also enables for collecting measured data of device in real time and its record to a file at *.csv form (reading by Excel).

Communication takes place by USB connector. After connection the device to PC is not necessary to install drivers.



8. Safety and installation rules

- Application of described devices at special meaning systems (eg. medical, at machines, etc.) requires using additional protection against working errors.
- Devices must be correctly mounted in panel. Not following to the rules can cause electric shock.
- Do not connect external devices if the device is turned on.
- Do not disassemble and make modifications to the device. If necessary, please contact us. Unauthorized alterations may result in electric shock or cause a fire. This causes a loss of warranty.
- This device cannot be exploited outside. It may result in electric shock and shorten proper functioning time of the device.
- External power supply connections should be made by ZOAWG cables.
- Exceeding recommended operating parameters can lead to damage the device or fire.
- For cleaning the device do not use cleaning products containing water or oils.