

OKBA

SERIES

INSTANTANEOUS BISTABLES RELAYS
4-8 CONTACTS

APPLICATIONS



OVERVIEW

- Plug-in instantaneous bistables (latching) relays
- Solid and rugged construction
- Considerable long-life
- Automatic de-energization following operation, energy saving
- Magnetic holding action
- Patent operating mechanism, designed to ensure high contact pressure
- Magnetic arc blow-out standard
- Independent and self-cleaning contacts
- Excellent shock and vibration resistance
- Wide range of sockets
- Positive mechanical keying for relay and socket

DESCRIPTION

OKBA relays are electromechanical devices having two stable states controlled by two distinct power inputs.

These relays are used mainly because they are able to maintain the status assumed after the last switching operation, even in event of a power outage occurring.

Given their superior **reliability** and **durability**, these components are capable of filling roles that call for a high level of responsibility; in effect, they are used in environments where continuous duty is an essential requirement (e.g. electrical transformer stations and continuous cycle manufacturing processes).

OKBA relays are equipped with a mechanism that cuts off the power supply to the coil leads after the switching operation; this means that **power consumption can be reduced to zero**, while maintaining the required operating position.

They have a **special element made of magnetic material**, which magnetizes when the relay is operated.

In the event of a power outage, the magnet is able to hold the contacts in the operating position with a force on the armature of 10N.

The magnet is demagnetized by a de-energize winding, which generates a magnetic field opposite to that of the energize winding, and allows the relay contacts to return to their initial position. The release winding forms part of the same coil that incorporates the latch winding. **Available in versions with 4 or 8 change-over contacts.**

Like all AMRA relays, OKBA models are assembled, calibrated and tested, individually and manually, as part of a sequential manufacturing process in which each step of production is tested automatically during the course of the subsequent step.

STANDARD COMPLIANCE

EN 61810-1	EN 60077
EN 61810-2	EN 50155
EN 61810-7	EN 60695-2-10
EN 61373	EN 61000
EN 45545-2	EN 60529
ASTM E162, E662	

MODELS	NUMBER OF CONTACTS	ROLLING STOCK APPLICATION
OKBA	4	•
OKBA8	8	

FOR PRODUCT CODE CONFIGURATION, SEE THE "ORDERING SCHEME" TABLE

COIL DATA

Nominal voltages Un ⁽¹⁾	DC: 24-36-48-72-96-110-125-132-144-220 AC: 24-48-110-127-220-230
Max. consumption at Un ⁽²⁾	7W / VA (latch) 3.5W / VA (unlatch) ⁽³⁾
Version for rolling stock at Un ⁽²⁾	12.5 (latch) 5.5W (unlatch)
Operating range	80...115% Un
Version for rolling stock	DC: 70...125% Un
Type of duty	Continuous

Minimum control pulse 100 ms.

(1) Other values on request.

(2) At the moment of the relay being switched. De-energization occurs after 100 ms approx. Power consumption with relay energized: BAS8NB = 0W; OKBA = 0.6 W / VA.

(3) For versions with 8 contacts, double the value.

CONTACT DATA

Number and type	4 SPDT, form C ⁽¹⁾
Current	Nominal ⁽²⁾ 10 A
	Maximum peak (1 min) ⁽³⁾ 20 A
	Maximum pulse (10 ms) ⁽³⁾ 150 A
Example of electrical life expectancy ⁽⁴⁾	0.5A - 110Vdc - L/R = 40ms : 10 ⁵ operations, 900 operations / hour
Minimum load ⁽⁵⁾	Standard contacts 500mW (20V, 20mA)
	Gold-plated contact P4GEO ⁽⁶⁾ 100mW (10V, 5mA)
Maximum breaking voltages	350 Vdc / 440 Vac
Contact material	AgCu
Operating time at Un (ms) ⁽⁷⁾	DC - AC
	Pick-up (NO contact closing) ≤ 30
	Drop-out (NC contact closing) ≤ 40

(1) Version with 8 SPDT contacts available.

(2) On all contacts simultaneously, reduction of 30%.

(3) The max. peak and pulse currents are those currents that can be handled, for a specified time, by the contact. They do not refer to steady or interrupted currents.

(4) For other values, see electrical life expectancy curves.

(5) Values referred to a new product, measured in laboratory. The ability to maintain this performance over the time depends on the environmental conditions and the contact' frequency use. The use of gold plated contacts is recommended in the case of very low loads.

(6) Specifications of gold-plated contacts on new relay

a) Plating material: **P4GEO**: gold-nickel alloy (>6μ)

b) When the gold-plated contact is subject to heavy loads, it will be degraded on the surface. In such case, the characteristics of the standard contact should be taken into consideration. This does not impair relay operation.

(7) Unless specified otherwise, the operating time signifies until stabilization of the contact (including bounces).

INSULATION

Insulation resistance (at 500Vdc)	
between electrically independent circuits and between these circuits and ground	> 1,000 MΩ
between open contact parts	> 1,000 MΩ
Withstand voltage at industrial frequency	
between electrically independent circuits and between these circuits and ground	2 kV (1 min) - 2.2 kV (1 s)
between open contact parts	2 kV (1 min) - 2.2 kV (1 s)
between adjacent contacts	2 kV (1 min) - 2.2 kV (1 s)
Impulse withstand (1.2/50μs - 0.5J)	
between electrically independent circuits and ground	5 kV
between open contact parts	5 kV



MECHANICAL SPECIFICATIONS		
Mechanical life expectancy	20x10 ⁶ operations	
Maximum switching rate	Mechanical	900 operations/hour
Degree of protection (with relay mounted)	IP20	
	4 SPDT	8 SPDT
Dimensions (mm)	45x45x109 ⁽¹⁾	92x45x109 ⁽¹⁾
Weight (g)	~ 300	~ 620

(1) Output terminals excluded.



ENVIRONMENTAL SPECIFICATIONS		
Operating temperature	Standard	-10° to +55°C
	Version for railways, rolling stock	-25° to +70°C
Storage and shipping temperature		-25° to +70°C
Relative humidity		Standard: 75% RH - Tropicalized: 95% RH
Resistance to vibrations		1g - 10 to 55 Hz
Resistance to shock		3g
Fire behaviour		to EN 60695-2-10



STANDARDS AND REFERENCE VALUES	
EN 61810-1, EN 61810-2, EN 61810-7	Electromechanical elementary relays
EN 60695-2-10	Fire behaviour
EN 61000	Electromagnetic compatibility
EN 60529	Degree of protection provided by enclosures

Unless otherwise specified, the products are designed and manufactured according to the requirements of the above-mentioned European and International standards.

In accordance with EN 61810-1, all technical data are referred to ambient temperature of 23°C, atmospheric pressure of 96kPa and 50% humidity.

Tolerance for coil resistance and nominal power is ±7%.



RAILWAYS, ROLLING STOCK - STANDARDS	
EN 60077	Electric equipment for rolling stock - General service conditions and general rules
EN 50155	Electronic equipment used on rolling stock
EN 61373	Shock and vibration tests, Cat 1, Class B
EN 45545-2	Fire behaviour, Cat E10, Requirement R26, V0
ASTM E162, E662	Fire behaviour



CONFIGURATIONS - OPTIONS	
P2	Tropicalization of the coil with epoxy resin for use with 95% RH (@ T 50 °C). This treatment also protects the coil against corrosion which could occur by combination of the humidity with certain chemical agents, such as those found in acid atmospheres (typical of geothermal power stations) or saline atmospheres
P4GEO	Gold plating of contacts with gold-nickel alloy, thickness ≥ 6μ. This treatment ensures long-term capacity of the contact to conduct lower currents in harsh ambient conditions such as acid atmospheres (typical of geothermal power stations) or saline atmospheres
P5GEO	P4GEO gold-plating of contacts + P2 coil tropicalization
P6GEO	P4GEO type gold-plating, but applied to contacts, contact terminal and output terminals + P2 coil tropicalization
DIODE	Polarized component connected in parallel with the coil (type 1N4007 or BYW56 for rolling stock version) designed to suppress overvoltages generated by the coil when de-energized.
IP40	IP40 protection with "6" handle or closure with screws.
8 CONTACTS	Version with 8 change-over contacts, obtained using 2 x 4 SPDT relay, coils connected in series.
LOW TEMPERATURE (OKBA, 4 SPDT only)	Minimum operating temperature -40°C, only for Rolling stock version (option "L").



ORDERING SCHEME

PRODUCT CODE	NUMBER OF SPDT CONTACTS	APPLICATION ⁽¹⁾	CONFIGURATION A	CONFIGURATION B	TYPE OF POWER SUPPLY	NOMINAL VOLTAGE (V) ⁽²⁾	KEYING POSITION ⁽³⁾ / OPTION
OKBA	4: 4 SPDT ⁽⁴⁾ 8: 8 SPDT	E: Energy F: Railway Fixed Equipment R: Railway Rolling Stock	1: Standard 2: Diode //	0: Standard 2: P2 4: P4 GEO 5: P5 GEO 6: P6 GEO	C: Vdc A: Vac 50 Hz	024 - 036 - 048 072 - 096 - 110 125 - 127 - 132 144 - 220 - 230	XXX L: low temperature

Example

OKBA		E	1	0	C	144	
OKBAE10-C144 - OKBA relay, ENERGY series, nominal voltage 144 Vdc							
OKBA	8	E	1	2	C	024	
OKBA8E12-C024 - OKBA relay, ENERGY series, nominal voltage 24 Vdc, equipped with 8 contacts and P2 finish (tropicalization of coil)							

(1) ENERGY: all applications except for railway.

RAILWAYS, FIXED EQUIPMENT: application on fixed power systems and electrical railway traction.

Construction according to RFI (FS Group) specification no. RFI DPRIM STF IFS TE 143 A, if applicable.

For list of RFI compliant and type-approved products, consult dedicated catalogue "RAILWAY SERIES – RFI APPROVED".

RAILWAYS, ROLLING STOCK: application on board rolling stock (rail-tram-trolley vehicles). Electrical specifications according to EN60077.

Also available is the **STATIONS** series, with ENEL approved material meeting LV15/LV16 specifications.

For list of ENEL compliant and type-approved products, consult dedicated catalogue "STATIONS SERIES – LV15-LV16-LV20".

(2) Other values on request.

(3) Optional value. The positive mechanical keying is applied according to the manufacturer's model.

(4) For the standard version with 4 contacts, the field must be left empty.



WIRING DIAGRAM

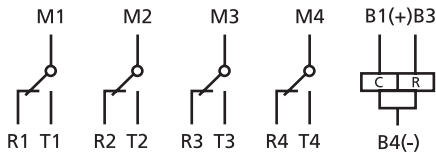

OKBA

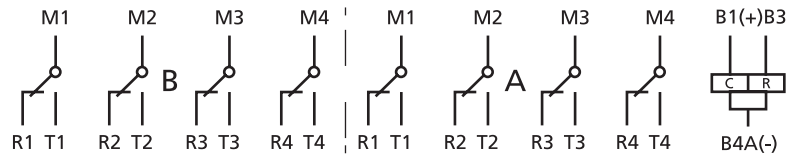

OKBA 8 CONTACTS



DIMENSIONS

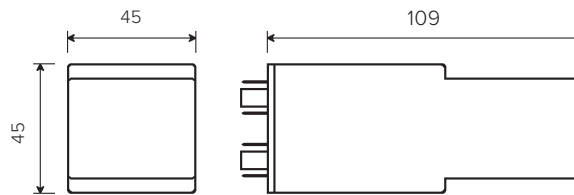

OKBA

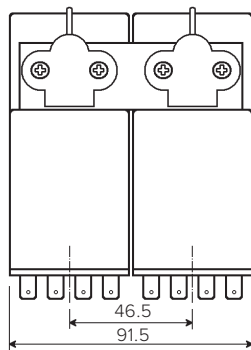

OKBA 8 CONTACTS

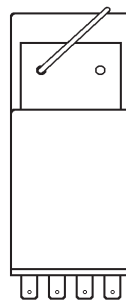

6B HANDLE IP20 (STANDARD)

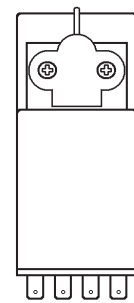

6 HANDLE IP40

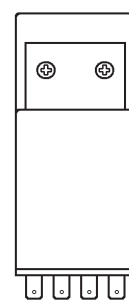

CLOSURE WITH SCREWS IP40

SOCKETS AND RETAINING CLIPS - OKBA, 4 SPDT ⁽¹⁾	SOCKET	RETAINING CLIP ⁽²⁾
Number of terminals (standard dimensions 5x0.8mm)	16	
For wall or rail mounting		
Spring clamp, wall or DIN H35 rail mounting	PAIR160	RL48
Screw, wall or DIN H35 rail mounting	48BIP20-I DIN	RL48
Screw, wall mounting	48BL	RL48
Double faston, wall mounting	48L	RL48
For flush mounting		
Double faston (4.8 x 0.8 mm)	ADF2	RL48
Screw	43IL ⁽³⁾	RL43
For mounting on PCB		
	65	RL43

(1) For version with 8 contacts, assume 2 sockets respectively for each relay. In this instance, the mounting distance between centres of the sockets must be 45 mm. The ADF socket cannot be used.

(2) Assume 2 clips for relays with 8 contacts.

(3) Insert the clip before fastening the socket to the panel.
For more details, see specifications of mounting accessories.

ELECTRICAL LIFE EXPECTANCY

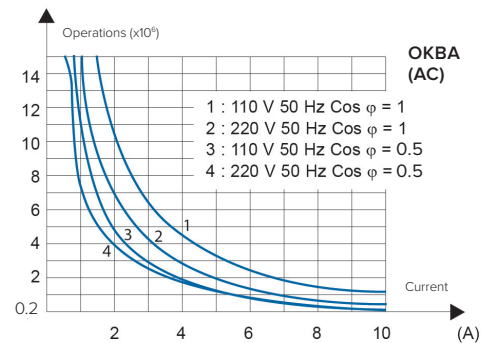
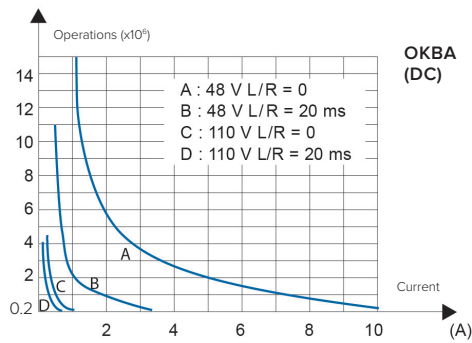

OKBA: other examples of electrical life expectancy available on the technical data sheet of the OK series relay (OKSFC model)

INSTALLATION, OPERATION AND MAINTENANCE

Installation

Before installing the relay on a wired socket, disconnect the power supply.

The preferential mounting position is on the wall, with the relay positioned horizontally in the "reading orienting" of marking so that the label is readable in the correct sense.

Spacing: no relay spacing is required.

For a safe use, the retaining clip is recommended.

For use on rolling stock, relays have been tested to EN 61373 standard equipped with retaining clip(s).

Operation

Before use: if relay is not used, for example after long storage periods, contact resistance may increase due to a natural and slight oxidation or polluting deposits.

In order to restore the optimal conductivity and for standard contacts (**NOT gold plated**) it is recommended to switch several time a load of at least 110Vdc - 100mA or 24Vdc - 500mA. The contacts will be "cleaned" thanks to the electric arc generated during the current interruption and the mechanical self-cleaning action.

The common contact rubs against the fixed poles (NO and NC contacts) both when opening and when closing, which ensures a self-cleaning action.

An increase in contacts' resistance, in most cases, does not represent a problem. Many factors contribute to the correct use of contact and consequently to the relay' long-term reliability:

- **Load:** the current switching generates an electric arc with cleaning effects. For proper electrical cleaning and performance keeping we recommend:
 - o Standard contacts: Minimum current = 20mA
 - o Gold plated contacts: Minimum current = 10mA
- **Operating frequency:** relays are components that can operate with a wide range of switching frequency. High frequency operation also allows a continuous cleaning effect by "sliding" (mechanical cleaning). In case of low frequency operation (for example few time a day), we advise:
 - o Use of contact with currents twice compared to those indicated.
 - o For currents lower than 10mA, use gold plated contacts and connect 2 contacts in parallel, in order to reduce the equivalent contact resistance
- **Pollution:** the presence of pollution can cause impurities on contact surface. Electric charges attract organic molecules and impurities that are deposited on the contact surface. Electrical and mechanical cleaning, respectively, burn and remove such impurities. In pollution presence, the minimum recommended currents must be respected. In extreme cases, provide double the cleaning current.

Condensation is possible inside the relay when energized and the outside ambient temperature is cold; this is quite normal and does not affect the operation of the relay. Plastic materials of relay do not possess hygroscopic properties.

Maintenance

No maintenance is required.

In case of normal relay wear (reaching the end of electrical or mechanical life), the relay cannot be restored and must be replaced.

To check the component, relay removal must be carried out with slight lateral movements. An "up and down" movement can cause terminals damage.

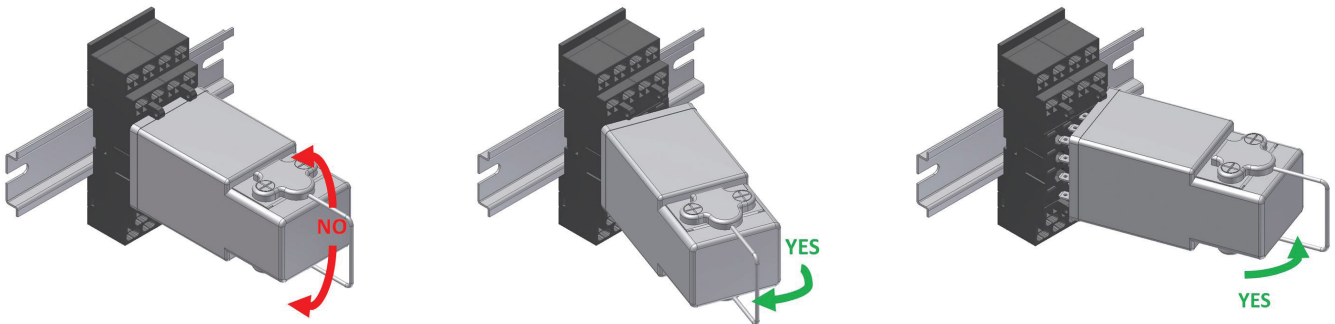

Often the malfunctions are caused by power supply with inverted polarity, by external events or by use with loads exceeding the contact performance.

In case of suspected malfunction, energize relay and observe if mechanical operation of contacts / relay mechanism is performed. Pay attention to the power supply polarity, if relay is equipped with polarized components (example: diode, led).

- In case of expected operation, clean the contacts (see paragraph "OPERATION") and check if the circuit load ranges within the contact performance. If necessary, replace with relays with gold contacts. Note: the electrical continuity of contacts must be checked with adequate current.
- If it does not work, we recommend to use a relay of the same model and configuration.

If an investigation by AMRA is required, pull-out the relay from the socket, don't remove the cap, avoid any other manipulation and contact us. You will be asked for the following data: environmental conditions, power supply, switching frequency, contact load, number of operations performed.

The fault can be described through the "TECHNICAL SUPPORT" section of the website www.amra-chauvin-arnoux.it.

In any case, the relay cannot be repaired by the user.

Storage

Storage conditions must guarantee the environmental conditions (temperature, humidity and pollution) required for the product conservation, in order to avoid deterioration.

The product must be stored in an environment sheltered from atmospheric agents and not polluted, with an ambient temperature between -25 and +70°C with max 75% RH. Humidity can reach peaks of 95%. In any case, there must be no condensation. Before use, please read carefully "OPERATION" section.